



LIGHT TECHNOLOGY



Studio 24 *scan control*

professional light desk user's manual
rel. 1.41

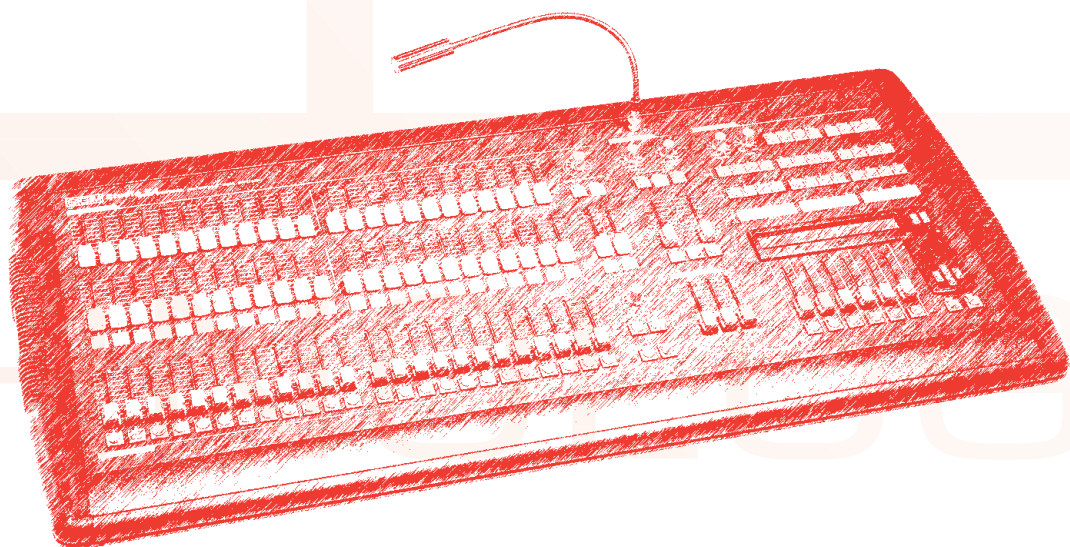

General instructions

Read the instructions in this handbook carefully, as they give important information regarding safety during installation, use and maintenance.

Be sure to keep this instruction manual with the fixture in order to consult it in the future. If the fixture is sold or given to another operator, make certain that it always has its manual, to enable the new owner to read about its operation and relative instructions.

- This unit is not intended for home use.
- After having removed the packaging, check that the fixture is not damaged in any way. If in doubt, don't use it and contact an authorized SGM Technical Service Centre.
- Packaging material (plastic bags, polystyrene foam, nails, etc.) must not be left within children's reach, as it can be dangerous.
- This fixture must only be operated by adults. Do not allow children to tamper or play with it.
- Electrical work necessary for installing the fixture must be carried out by a qualified electrician or experienced person.

Never use the fixture under the following conditions:

- In places subject to excessive humidity
 - In places subject to vibrations or bumps.
 - In places with a temperature of more than 45°C or less than 2°C
 - Protect the fixture from excessive dryness or humidity (ideal conditions are between 35% or more 85%).
- The fixture must not be installed less than 1.5m. from the surface or object to be lit.
 - Do not dismantle or modify the fixture.
 - Make certain that no inflammable liquids, water or metal objects enter the fixture.
 - Should any liquid be spilled on the fixture, disconnected the power supply to the lighting control desk immediately.
 - In the event of serious operating problems, stop using the fixture immediately and either contact the nearest SGM sales point for a check or contact the manufacturer directly.
 - Do not open the fixture - there are no user serviceable parts inside.
 - Never try to repair the fixture yourself. Repairs by unqualified people could cause damage or faulty operation. Contact your nearest authorized service centre.

Always insist that original spare parts are fitted.

Safeguard the environment: don't throw batteries, accumulators or packaging material into your waste bin. Return them to your reseller or take them to the nearest special waste collection point.

Index

1	General instructions	24
2	Index	24
3	0 - Handbook layout	25
4	1 - Studio 24 Scan Control console layout	25
4	1.1 - Main features	26
4	1.2 - Technical specifications	26
5	1.3 - Studio 24 Scan Control's sections	26
5	1.3.1 - Manual Presets	26
5	1.3.2 - Registers	27
5	1.3.3 - Light Chase Controls	28
6	1.3.4 - Masters	28
6	1.3.5 - DMX Unit Controls	29
7	1.4 - Studio 24 connectors	30
7	1.4.1 - DMX 512	30
7	1.4.2 - Up-Down pedal	31
7	1.4.3 - SMPTE	31
7	1.4.4 - Midi	32
7	1.4.5 - RS-232	33
7	1.4.6 - Audio In	35
8	1.4.7 - Disconnecting the power supply	35
8	2 - Console maintenance	35
8	2.1 - Access to internal components	36
8	2.2 - Cleaning and periodical checks	36
9	3 - Studio 24 Scan Control operating modes	36
10	4 - Manual Presets section	36
10	4.1 - Manual Presets in double preset mode	37
11	4.1.1 - Go function	37
11	4.1.2 - Solo function	37
11	4.1.3 - Link function	38
11	4.2 - Manual Presets in single preset mode	38
12	4.2.1 - Go function	38
12	4.2.2 - Solo function	38
12	4.2.3 - Link function	38
13	5 - Registers section	38
13	5.1 - Memory pages	38
13	5.2 - Register operating modes	39
14	5.3 - Storing a scene	39
14	5.4 - Modify a stored scene	39
14	5.5 - Copying a stored scene to another scene	39
15	6 - Light Chase Controls section	40
15	6.1 - Chase running	40
16	6.2 - Creating and modifying chases	40
17	7 - DMX Unit Controls section	41
18	7.1 - Direct mode use	42
19	7.1.1 - Program elements	42
19	7.2 - Groups of units	45
20	7.3 - Movement effects	46
20	7.4 - Use in Reg mode	47
21	7.5 - The Utilities	50
21	7.5.1 - Remote lamp ignition	51
21	7.5.2 - Remote fixture reset	
21	7.5.3 - Operating areas	
22	7.6 - Creating a program	
23	7.6.1 - Copying a scene	
23	7.6.2 - Copying a program	
23	7.6.3 - Adding a Program to a Memory Register	
24	8 - Setup functions	
24	8.1 - Addressing light channels	
	8.1.1 - Equalization curves	
	8.2 - Addressing the fixtures	
	8.3 - Changing the language used	
	8.4 - Available memory	
	8.5 - Built-in memory	
	8.5.1 - Creating a new unit	
	8.5.1.1 - DMX channel total	
	8.5.1.2 - LCD effect labels	
	8.5.1.3 - Internal addressing	
	8.5.1.4 - Standby values	
	8.5.1.5 - Type of effect	
	8.5.1.6 - Mirror/Head	
	8.5.1.7 - Slope Speed	
	8.5.1.8 - Unit name	
	8.5.1.9 - Remote and lamp reset values	
	8.5.1.10 - Dip-switch configuration	
	8.5.1.11 - Beam search values	
	8.5.1.12 - Type of control	
	8.5.2 - Error messages	
	8.5.3 - Modifying a unit in the library	
	8.5.4 - Deleting a unit from the library	
	9 - Using the connectors	
	9.1 - Pedal	
	9.2 - SMPTE socket	
	9.3 - Midi connectors	
	9.3.1 - Midi In - Note On	
	9.3.2 - Midi In - Note Off	
	9.3.3 - Midi In - Program Change	
	9.3.4 - Midi In - All Channels Off	
	9.3.5 - Midi In - Bank Select	
	9.3.6 - Midi Out - Program Change	
	9.3.7 - Midi Out - Bank Select	
	9.4 - RS-232 connections	
	9.4.1 - RS-232 - Channel On (01h)	
	9.4.2 - RS-232 - Channel Off (A2h)	
	9.4.3 - RS-232 - All Off (A3h)	
	9.4.4 - RS-232 - Register Change (A0h)	
	9.4.5 - RS-232 - Page Change (A4h)	
	9.4.6 - RS-232 - Device Select (A6h)	
	10 - Using 'Event Recording'	
	10.1 - 'Event Recording' operating modes	
	10.2 - Creating a track	
	10.3 - Replaying a track	
	11 - Advanced use of the Studio 24 Scan Control	
	11.1 - Multiple units	
	11.2 - Multiple scanner units	
	11.3 - Using the colourchangers in pseudo-random mode	
	12 - Quick Reference	
	12.1 - Tree structure diagram of Setup functions	
	13 - Practical users guide	

0 - Handbook layout

All the parts of this user's manual have been laid out in such a way as to facilitate learning the details of the Studio 24 Scan Control console.

Each section is presented using the simplest possible terminology, although remaining necessarily technical.

The new range of consoles to which the Studio 24 Scan Control belongs has been designed to ensure the utmost user-friendliness.

Chapters 1 and 2 are deliberately generic and conversational and have the job of introducing the unit.

The advanced use described in chapter 11 isn't "totally technical", but suitably documented.

On the previous page, the index also gives an initial idea of how explanations of functions and commands are divided, always beginning with the easiest and working up to the most complicated.

We suggest even experienced operators read this manual in its entirety, as it's often possible to appreciate every nuance in the logic of the unit's design only after completely understanding the reasoning behind every choice made when designing both hardware and software.



LIGHT TECHNOLOGY

Designed and Manufactured in Italy by SGM Elettronica srl

Printed in March, 1999 • Rel. 1.41

GB

I

D

F

E

appendice

1. Studio 24 Scan Control console layout

1.1 Main Features

SGM's new Studio 24 Scan Control console is one of the results of our long experience in the manufacture of this type of control equipment, and is able to control 24 or 48 dimmer channels and 12 intelligent fixtures using up to a maximum of 36 DMX 512 serial digital signal channels.

The quality and design policy are those the trade has come to expect from SGM and the sophisticated electronics used, combined with ground-breaking performance, places this unit among the best international products. Careful in-depth study of the functions, an on-going search for innovative materials, technical updating and constant research aimed at even greater safety have resulted in the realization of this unique product.

The unit's structure and electronics were entirely designed by our R&D lab, ensuring we have complete command of the know-how and are able to offer the best possible quality/price ratio.

Like all other SGM products, before being put on the market these consoles underwent a lengthy burn-in period, passing the strict tests with brilliant results: further proof of their high quality and reliability.

The great care taken with the lines and optimisation of the external structure to ensure utmost user-friendliness enable them to be easily installed and facilitate any necessary maintenance work to the utmost.

The Studio 24 Scan Control is built in compliance with current CE norms.

1.2 Technical Specifications

Power supply:	External AL4 (+12V DC, 2A max.) - cod. 003-1286
Power required:	+12V DC 1,000mA (+420mA for the service light)
Power absorbed:	12W (+5W max for the service light)
Symbols used:	The printing indicates levels using a scale of 0÷10, chosen to indicate percentages in a simplified manner (e.g. 10 = 100%).
Electronics:	Features CS 0238 + 0239 (main logic circuits); CS0233+0234+0235+0236 (Scan Control group); CS 0231 (master circuit); CS 0232 (channel circuit - 2 of)
Storage protection:	A dipswitch allows programs and/or Setup to be protected
Setting:	Via dipswitches (for RS-232 and MIDI)
Inputs/Outputs:	DMX IN/OUT via 5-pin XLR-F connector (*) for serial digital return signal; 6.3mm. stereo jack for up/down register change pedal; 6.3mm. unbalanced stereo jack for Audio IN - 0dB, mono (or left) DB9 connector for RS-232 serial connection with a personal computer; 3-pin XLR-F for SMPTE signal input; Standard 5-pin DIN connector for MIDI IN-THRU. 3-pin XLR-F socket for service light (max 12V 5W)
DMX512 channels:	24 or 48 for dimmer channels, 432 for intelligent fixtures (512 max, total)
Fixture Body:	Sheet metal with epoxy powder finish
Dimensions:	(9.5 x 102 x 49)cm. Weight: 17.5kg.

(*) wired for DMX return signal, not operative with this software version.

SGM Elettronica reserves the right to improve or modify their products at any time without prior notice. Always consult the handbook of the unit being used to avoid errors and differences between the actual functions and those shown in the book.

1.3 Studio 24 Scan Control's sections

1.3.1 - Manual presets

This is the most traditional area of lighting consoles and comprises 2 rows of 24 faders each, which can be used as two 24 channel presets (A+B) or as a single 48-channel preset (A); 2 faders used as masters for presets A and B; 2 buttons for enabling presets A and B (when working in A+B mode) or switching the 24 buttons relative to the channels between the two banks of 24 which make up preset A (when working in 48-channel mode); 1 button for enabling the SOLO function and 1 button for enabling the LINK function.

Mixing work between preset A and B (when working in A+B mode) can be done by setting the time with the MANUAL PRESET CROSS TIME potentiometer.

This is a completely manually operated section and recognisable by its light grey knobs and printing.

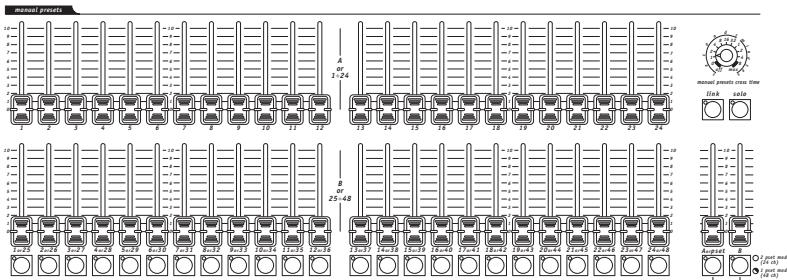

1.3.2 - Registers

This section comprises a row of 24 faders for regulating the Memory Registers.

Passing from one register to another can be done setting the time with the REGISTERS CROSS TIME potentiometer. This section also includes GRAB, PLAY, RECORD, PAGE and MODE function buttons.

This is a completely automated section and recognisable by its dark grey knobs and light blue printing.

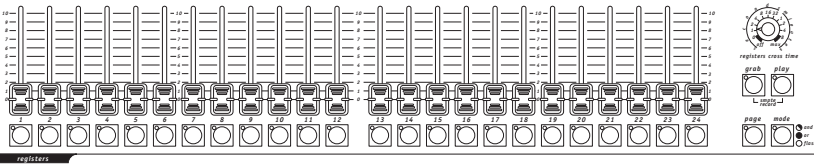

1.3.3 - Light chase controls

This zone is used for creating and controlling chases, i.e. sequence effects obtainable using traditional luminaires controlled by the dimmers.

With Studio consoles, It's possible to send chases directly to the GRAND MASTER and the memory registers, so several chases can be output simultaneously, 2 of which are accessible in real time (1 via the REG control, the other via DIRECT). Chases created can have a maximum of 24 steps, and it's possible to enable only the required steps of a chase. Steps can be just simple channel on/off commands or channels can be switched on at a required level.

light chase controls

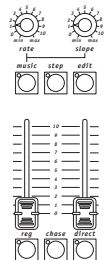

Chase runs are controlled by the SLOPE and RATE potentiometers, and can be run in sync with a music signal.

1.3.4 - Masters

The Studio console has 3 masters, i.e. general level controls. The REG master controls the outputs of the memory registers, the FLASH master controls the level of the FLASH buttons and the GRAND MASTER controls the overall output level of all the channels, including the REG master. The FLASH MASTER level is independent from that of the GRAND MASTER.

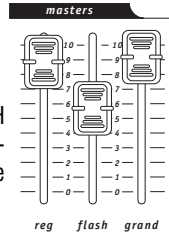

1.3.5 - DMX unit controls

This section includes the console's built-in universal controller, able to control 12 units of any type (dimmers, scanners, moving head units, etc.) which use DMX protocol and a maximum of 36 channels each.

Six channels are reserved for Pan, Tilt, Reset and Lamp functions: the remaining 30 can be freely used for any type of unit.

A row of buttons give access to the main functions (MUSIC, BKWARD, PAUSE, STORE, REG, DIRECT, UTIL, SETUP). Three rows of buttons are used to select the programs (PROG), scenes (SCENE) and units (UNITS).

Individual DMX channel levels are monitored on the large LCD, under which there are 6 sliders that control the function shown on the display.

Moving head unit or scanner control is completed by a joystick (operating on absolute co-ordinates) and 4 cursor buttons (operating on relative co-ordinates). The combination of these two systems ensures extremely precise control of fixture positioning.

This is a completely automatic section, recognisable by its dark grey knobs and light blue printing, except the UNIT buttons, which are for manual control, so are light grey.

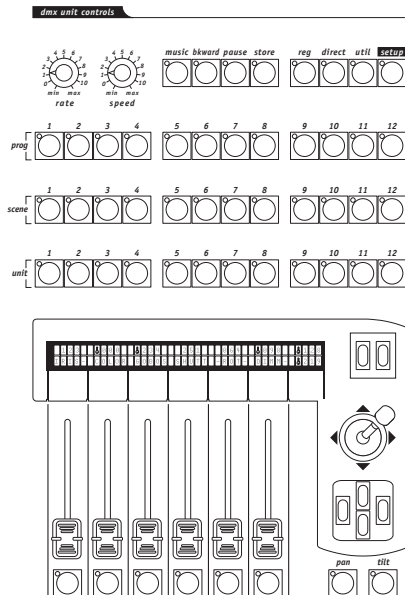

1.4 Studio 24 connectors

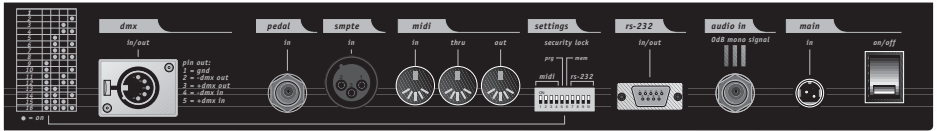

1.4.1 - DMX 512

Studio consoles have DMX 512 input/output. At present, the input isn't enabled by the software. Balanced 2 x 0.25mm² RS-485 cables should be used for connection and must be good quality to avoid faulty equipment operation.

Attention: cables' screen (braid) must NEVER be connected to the system's ground, as this will cause faulty fixture and controller operation.

1.4.2 - Up-down pedal

This socket allows a pedal to be connected to the console for stepping up and down through the registers. Stepping is between registers on the same page (see PAGE function). If UP and DOWN are pressed simultaneously, the register is switched off. Registers are enabled by pressing UP (starting with register 1) or DOWN (starting with register 24).

1.4.3 - SMPTE

The SMPTE signal allows operators to record series of events in sync with an SMPTE time code. This ensures absolutely precise sync, ideal for musical, television and theatre applications.

1.4.4 - MIDI

The Studio console has MIDI In, Thru and Out connections, which offer a considerable amount of functions. See the relative chapter for details.

1.4.5 - RS-232

By means of this connector, the console can be linked to a personal computer. This offer a remarkable amount of functions (see the relative chapter for details).

1.4.6 - Audio in

This socket is used to enable all the music sync functions available on the console. When there's no direct connection to an audio source, the built-in microphones is used. A 0dB mono, signal LINE signal is required. The left channel of a stereo signal can be used as an alternative.

sockets pin out

dmx 512



- 1: gnd
- 2: -dmx out
- 3: +dmx out
- 4: -dmx in
- 5: +dmx in

pedal u/d

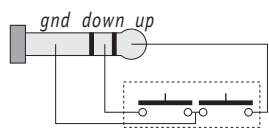

smpte



- 1: gnd
- 2: signal hot
- 3: signal cold

rs-232



- 2: rx
- 3: tx
- 5: gnd
- 7: rts
- 8: cts

audio

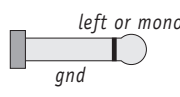

main in

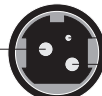

- +V DC
- n.c.
- gnd

1.4.7 - Disconnecting the power supply

Studio consoles are powered by an AL4 switching power supply. This is fitted with a connector plug which has a small built-in locking mechanism to prevent accidental disconnection. To disconnect the power supply from the console, always grip the plug, not the cable, as shown in the diagram:

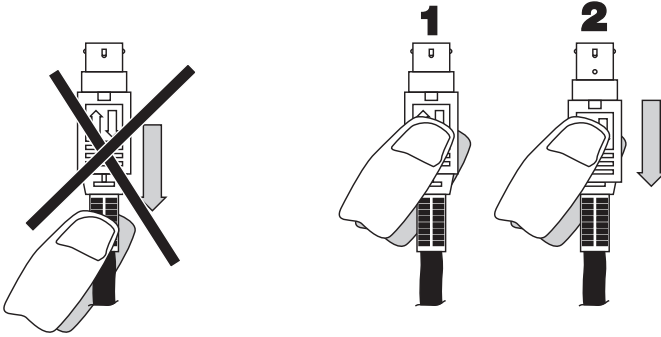

Before disconnecting the power supply, always remember to switch off the console.

2 - Console maintenance

2.1 Access to internal components

Studio consoles have a system for access to internal components which prevents them being opened accidentally. To carry out any necessary work, unscrew the two screws on the sides of the console, below the plastic side panels (it's not necessary to remove the screws completely). Then raise the work surface, holding it by the grip located under the handrest profile.

Due to the type of unit and the characteristics of the circuits fitted, it's inadvisable to open the console: only qualified technical personnel can carry out work on the electronic components.

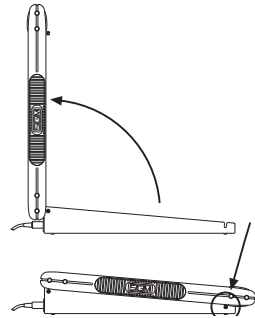

2.2 Cleaning and periodical checks

The console should be cleaned approximately every 300 hours, using compressed air to remove any accumulated dust. The unit's paint finish allows the unit to be cleaned with alcohol or similar products, but a non-abrasive cloth must always be used. Make absolutely certain to avoid damaging the display by pressing too hard. To ensure perfect unit efficiency, an overall check every 700 running hours is advisable. Electrical and mechanical parts must be checked by qualified technical personnel.



3 - Studio 24 Scan Control operating modes

On the Studio 24 Scan Control, the “traditional “ section, normally used for controlling dimmers can be used in two operating modes:

- with two 24-channel presets with the possibility of mixing the two (double preset mode);
- with one 48-channel preset (single preset mode).

Changing from one operating mode to another is extremely easy, even if it's not possible to change accidentally.

When the console is switched on, the mode in which the console is being used appears on the display for approximately 5 seconds:

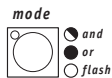
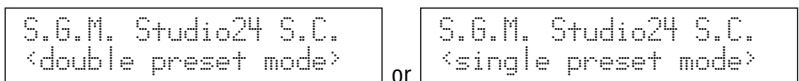

To change operating mode, with the console switched off, press the

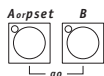

buttons and hold them down, then switch the console on.

The new operating mode will be shown on the display as already indicated.

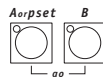

When the console is switched on in “double preset” mode, the two LEDs of the buttons flash simultaneously, whereas in single mode they flash alternately.

In the scenes stored in the REGISTERS in “single preset” mode on 48 channels, once the operating mode has been changed to “double preset” (i.e. with 24 channels), only the first 24 channels are output. The scenes aren't lost however: when the operator returns to “single preset” mode, the 48 channels are restored along with all their scenes.

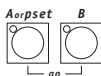

When “single preset” mode is used, the buttons are used to switch the presets' FLASH buttons from one 24-channel bank to the other: A for channels 1-24, B for channels 25-48. This is very important, because the FLASH button's LEDs are also used as channel level monitors.

Buttons A and B also have to be used to remove the group from 1 to 24 and 25 to 48 from LINK mode.

The preset's general level is only regulated by fader A and the MANUAL PRESET and Master B potentiometers aren't enabled.

In “double preset” mode, it's possible to mix presets A and B, either manually or automatically, using MANUAL PRESET CROSS TIME (see chapter 4).

Studio 24 Scan Control consoles' channels are set to operate with channels 1 - 48 as dimmer controls.

Should another setting be required, check the functions of the DMX UNIT CONTROLS section, which has powerful patching functions.

4 - Manual Preset section

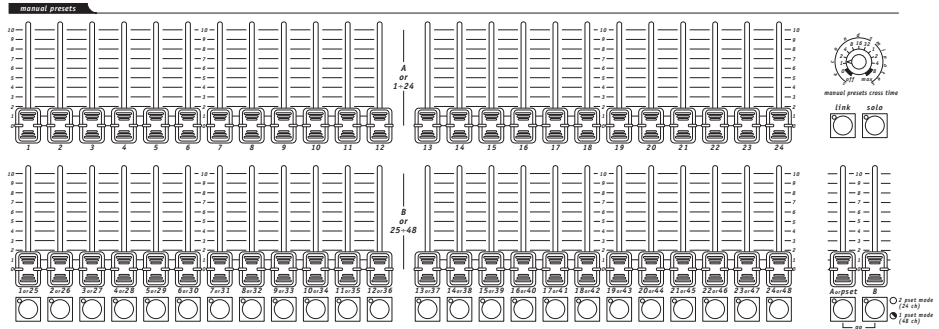

This section of the console is entirely manual and recognisable by its light grey fader knobs and buttons.

4.1 - Manual Presets in double preset mode

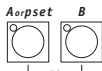
In this operating mode, the  buttons are used to enable presets A and B (so have on/off function). The output level of the two presets depends on that of the relative master. The selected level only depends on the GRAND MASTER: this means that if preset A's level is at 100%, and the GRAND MASTER is set at 80%, light output is just 80%.

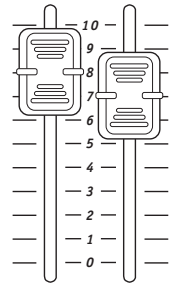

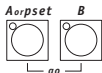
If, instead of pressing  simultaneously (GO function - parag. 4.1.1), both presets are switched off, no light will be output. In the same way, if both presets are switched on, the sum of the two presets will be output, combining instantly or gradually according to whether a cross time has been set or not.

If channel 10 is set at a level of 80% on preset A and at a level of 60% on channel B, the output won't be 140%, as Studio consoles use HTP (Highest Takes Precedence) technology: this means that the highest light intensity is output. So in this example, there's an output level of 80%.

The maximum output level of a preset or channel can never in any case be more than 100%.

The buttons below each preset have a green LED, which normally indicates the output level of the relative channel, whereas the button is used for the FLASH function.

The flash output level depends directly on the MASTER FLASH, which is independent of the GRAND MASTER.

Here again, HTP technology must be taken into consideration. In fact, if the MASTER FLASH level is set at a lower level than the "static" light (e.g. 60% compared with 100%), the flash will not be seen.

4.1.1 Go function

This control enables operators to pass from preset A to B, ensuring precise mixing constantly under control.

When one preset is off and the other on, pressing A and B simultaneously enables the GO func-

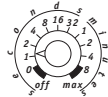

manual presets cross time

tion. In this case, the crossover between the two scenes is instantaneous if the potentiometer is set at 0 or OFF, otherwise it takes place in the time set, which can vary from 0 seconds to 8 minutes.

4.1.2 Solo function



The manual zone also includes the  function. When this is enabled (the relative LED is lit), the subtractive flash function is enabled. This means that if one of the 24 buttons is pressed, this all the channels are switched off apart from those on which flashing is enabled.

The general level depends as always on the MASTER FLASH.

4.1.3 Link function



The  function allows to select one or more channels and unlatch them from the control of MASTER A and B. In this mode, the output level depends on the position of the channel fader and (obviously) the GRAND MASTER.

Any variation in the level of a channel which is part of a stored scene can be transferred to the memory without reconstructing the entire scene. This option is also possible thanks to the LINK function (see chapter 5 - Memory registers).

4.2 - Manual presets in single preset mode

In this operating mode, the two rows of 24 faders of the manual zone become a single group of 48 channels. Preset B is no longer enabled.

Since there are only 24 FLASH buttons and the relative 24 LEDs for level monitoring, the

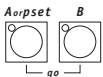

buttons are used to assign the following functions to the buttons:

A = flashing and monitoring channels 1 - 24

B = flashing and monitoring channels 25 - 48.

The output level of the single preset is controlled by Master A (Master B isn't enabled). The level selected depends only on the GRAND MASTER, which means that if Preset A's level is set at 100% and the GRAND MASTER level is 80%, the light output is limited to 80%.

The buttons located below each preset have green LEDs: these normally indicate the output level of the relative channel, whereas the button has FLASH functions. The flash output level depends directly on MASTER FLASH, which is independent of the GRAND MASTER.

Here again, HTP technology must be taken into consideration. In fact, if we set the MASTER FLASH level lower than the "static" light level (e.g. 60% compared with 100%), the flash won't be visible.

4.2.1 - Go function

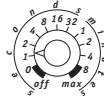

In this operating mode, the GO function and the *manual presets cross time* are not enabled.

4.2.2 - Solo function



The manual zone also includes the *solo* function. When this is enabled (the relative LED is lit), the subtractive flash function is enabled. This means that by pressing one or more of the 24 flash buttons, all the channels are switched off, apart from those on which Flash is being used. As already seen, if channels 25 - 48 have to be flashed, the banks of buttons have to be switched

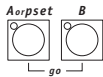

over using the *go* buttons.

4.2.3 - Link function

link



The *link* function allows to select one or more channels and unlatch them from the control of MASTERS A and B. In this mode, the output level depends on the position of the channel fader and (obviously) the GRAND MASTER level.

Any variation in the level of a channel which is part of a stored scene can be transferred to the memory without reconstructing the entire scene. This option is also possible thanks to the LINK function (see chapter 5 - Memory registers).

5 - Register Section

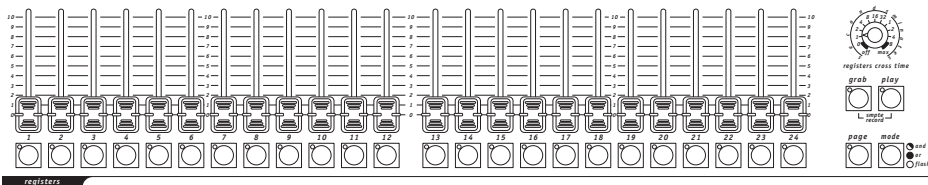

The REGISTER section is the “heart” of Studio 24 Scan Control consoles.

The memory registers are “containers” holding a fixed scene, a light chase and a “Scan Control” program, so a single command carries out three operations simultaneously. Being an automated section, it’s identifiable by the dark grey colour of the knobs and the light blue colour of the printing.

To enable a memory register, press the button below the register. The level is adjusted using the relative fader.

When a register is enabled at level 0, a weak flash of the relative LED warns operators that the register is enabled even if it’s not visible.

5.1 - Memory pages

The 576 memories available are divided into 24 pages of 24 registers each. To pass from one



page to another, use the  button. By pressing it and holding it down, one of the LEDs of the buttons numbered from 1 to 24 lights up, indicating the current page (if 1 lights up, this means page 1 is being used).

5.2 - Register operating modes

To ensure operators the utmost flexibility, the buttons below each memory register are also used to define the mode in which the actual registers operate. To set the registers’ operating mode,

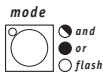

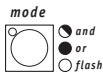
press and hold down the  button. The memory register buttons’ LEDs allow to identify the mode, according to the following table:

- flashing LED: AND mode. This is an overriding mode, which means that enabling an AND register causes another (already enabled) AND register to be faded out.
- LED fully lit: OR mode. This is an additive mode, which means that enabling an OR register adds the contents of the register to whatever is already enabled.
- LED 50% lit: FLASH OR FADER mode. This is an additive mode (like the OR mode) but as opposed to it, the buttons have a flash function. When the register button is pressed in this operating mode, output level depends on the MASTER FLASH. The level selected with the fader on the other hand depends on the MASTER REG and then the GRAND MASTER.
- LED off: FLASH mode. This is an additive mode, and when a register operates in this mode, it’s only enabled as long as the button is pressed. Output level is that set on the register and is affected by the MASTER REG and then the GRAND MASTER controls.

5.3 - Storing a scene

Transferring a scene prepared on the MANUAL PRESETS to a memory register is very simple. In



fact, operators only have to press the button and hold it down, followed by the button of the required register (from 1 to 24).

To add a channel to a Memory Register which is already stored, enable the required register, add



the required channel(s) (on preset A or B). Then press followed by the button of the register to be modified: the new scene is immediately updated and stored.

5.4 - Modifying a stored scene

To modify the level of a channel in a stored scene, it's not necessary to reconstruct the scene.



Once the register to be modified is enabled, press the button (it's in the MANUAL PRESETS zone), hold it down and then use preset A's faders (if in "double preset" mode) or the 48 faders in the "single preset" mode to set the required value.



Then press and hold it down, followed by the button of the register to be modified.

5.5 - Copying a stored scene to another scene

The procedure used to modify the contents of the registers can be used to copy one register's contents to another. The GRAB function takes a "snapshot" of all values of "dimmer" zone to Grand Master. So, if a light chase is active with a scene, when the operator use the GRAB function the snapshot include all the channels working at the grabbing moment.



To copy register 1 to register 2: just enable 1, press and, holding it down, press 2.

6 - Light chase control section

light chase controls

Studio consoles have a section dedicated to chases that are among the simplest, but at the same time the most powerful and flexible on the market.

This zone, dedicated to automated operations, is recognisable by its dark grey buttons and knobs and light blue printing.

Studio 24 Scan Control has 24 chases, each with 24 program steps.

The chase section has two operating modes: REG and DIRECT.

REG mode allows to assign a chase to a memory register and adjust output level, RATE and SLOPE of a chase being assigned or already assigned to a register.

DIRECT mode allows a chase to be sent directly to the GRAND MASTER and then out, regulating its level, RATE and SLOPE. Chases can only be created or modified in DIRECT mode.

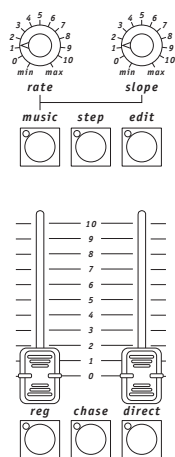

chase



The  button is used to select one of the 24 available chases. Press the button and hold it down: the buttons of the channels in the MANUAL PRESETS correspond to the chases. If a chase is enabled, the button's LED is lit. If no chases are enabled, all the LEDs are off.

step



The  function is used to select the required steps among those making up a chase. When assigning a chase to a memory register, it's also possible to assign it to several registers, changing the level, rate, slope and steps to be used in each case. There's therefore an almost endless number of possible variations.

step



To select the steps, press : and hold it down: the button's LED lights up and the buttons of the channels in the MANUAL PRESETS correspond to the steps. The lit LEDs indicate the enabled steps.

music



The  function allows to run the chases in sync with music. For the purpose, Studio 24 consoles are fitted with a built-in microphone and an audio input which automatically excludes the microphone.

When working in MUSIC mode, only SLOPE regulation remains enabled: the music rhythm replaces RATE.

6.1 - Chase running

The first almost unique feature is that of having twin chase speed regulation.

Two potentiometers (RATE and SLOPE) control the total length of single steps and the time taken to pass from one step to another respectively, as shown in this diagram.

This allows to have a chase with clear-cut crossovers from one step to another or a “gradual” crossover, carried out with “micro mixing” between steps.

Without this type of regulation, the only way to “smooth” the crossover from one chase step to another is to rely on the lamp filament’s dousing inertia, which operators cannot control directly.

When adjusting chases’ running, the step length (RATE) of the chase depends on the ignition and dousing times of the lamp being used (PAR 64 and PAR 56 lamps have different times).

If the SLOPE is longer than the RATE, the visual effect is that of a clear-cut immediate step from one step to another, as the highest point of the SLOPE curve cannot exceed the RATE’s, consequently eliminating the upward curve and giving clear-cut ignition.

On Studio consoles, it’s also possible to set the level of the channels in a step.

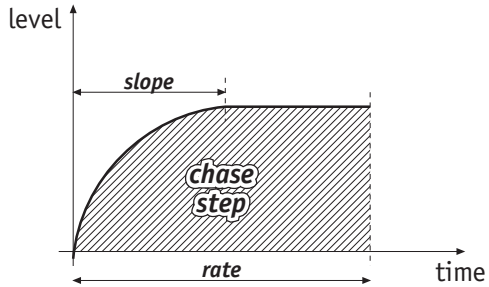

6.2 Creating and modifying chases



The  function is only enabled in DIRECT mode and only when a chase is selected before enabling it. To create a chase, or modify one that already exists, the procedure is the same, as no particular procedure is required for storing: exiting EDIT automatically saves the new chase or the variation carried out.

In EDIT mode the step to be created is selected with the same procedure normally used to select



the steps to use: by pressing and holding down the  button followed by one of the channel

buttons in the MANUAL PRESETS, then releasing the  button.

When creating a chase step, pressing the FLASH buttons enables the channel in on/off mode (the most common for creating chases), whereas the faders are used to set the required light level.

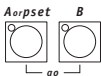
When the console is in “double preset” mode, Preset A faders are used, whereas in “single preset” mode all the 48 controls are enabled. When in this operating mode, it must be remembered



that the   buttons are used to switch over on/off settings in groups of 24 channels. 24 steps are available for each chase in both “double preset” and “single preset” mode.

7. DMX Unit Control Section

This section of the console comprises a universal controller for units requiring a maximum of 36 control channels, 6 of which are dedicated to movement functions (Pan & Tilt, 4 channels), remote unit reset and remote lamp ignition.

The majority of the functions involve automation, so the section's recognisable by its dark grey knobs and buttons and light blue printing.

This section's logic is the same used for the Chase section: programs can be output independently or added to a memory register (with DIRECT, STORE and REG functions respectively).

The section, which shall be called "Scan Control" to simplify matters, is able to control 12 units by means of 12 programs with 12 scenes each. Units can be controlled individually or in groups.

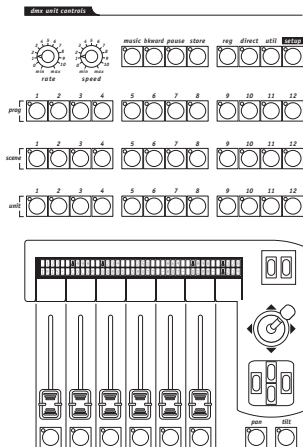



Scan Control has a control for music sync ( function) and a control for inverting the direc-

tion the scenes run in: pressing the  button, the scenes, which normally run from 1 to 12, will run backwards (from 12 to 1).

The  function allows to "freeze" the program being run at one scene. When the button is pressed, the scene running at that moment is finished and the program run suspended. The operator can then press any scene button to pass to a new scene, not necessarily the one before or the one after the scene put on pause, or can pass to another program. For as long as pause is enabled, the effects will continue working (e.g. gobo or prism rotation), whereas the movement will be finished (unless they are factory-programmed effects - see parag. 7.3).

As with the Light Chase Control section, Scan Control can only be used to create programs in DIRECT mode. When a variation is made to a scene, the PAUSE function is automatically enabled: remember to disable it to start the program running again!

The  function is used to transfer a selected program to a memory register with all its relative options (Speed, Rate, Music, Bkward, Scene, Unit and Effects).

The  button gives access to the console's so-called "utility" functions:

- remote fixture reset
- lamp ignition and dousing
- definition and control of the operating area for scanners and moving head units.

The section is completed by two rotary pots for adjusting programs' running parameters:

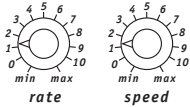

. RATE regulates the crossover time from one scene to another in a program, while SPEED regulates the speed of the mirror or moving head and the effects set on “SOFT” in the fixture library.

When a fixture is selected (to create a scene or carry out manual variations while a program’s running), the description of the effects the fixture has at its disposal appears on the display. The faders under the name of the function allow the parameters to be varied.

On the right of the display are two buttons with SCROLL functions for scrolling through the fixtures’ control functions in blocks of 6.

The joystick is used to move the mirrors and moving heads with an absolute co-ordinate system, which means that the joystick movement corresponds exactly with the movement of the mirror (in the case of a scanner) and the four corners correspond with the maximum limits of the mirrors.

The four buttons under the joystick have a “CURSOR” function and are used to run through the parameters on the display during the creation of the units and to move mirrors and moving heads with a relative co-ordinate system: this means that pressing a button corresponds with one step of the mirror’s movement, no matter where it was before the button was pressed.

If the cursor buttons are pressed and held down, the button’s autorepeat function is enabled and the speed increases exponentially to the maximum.

The combination of the two positioning systems (joystick and cursors) ensures very accurate fast positioning.

7.1 - Direct mode use

As with the Light Chase Control section, the Scan Control Section can operate in two modes: Direct and Reg (see 7.4).

When Scan Control is in DIRECT, it’s possible to control one or more fixtures manually, by pressing one of the UNIT buttons (1-12) to select the required fixture. The modifiable parameters appear on the display and the selected fixture’s LED flashes. When operating with individual fixtures, the relative button’s LED flashes. If another fixture is selected without de-selecting the previous fixture, the LED of the “old” fixture remains constantly lit. The flashing LED always indicates that the controls are enabled for that fixture.

When a fixture is de-selected, Scan Control automatically sets the “standby” parameters which the operator has entered in the fixture library, e.g. the closure of the shutter or dimmer.

When a fixture is re-selected for manual control, the operator finds the parameters set the last time manual work was carried out, with the only difference that the standby values will have replaced those previously set.

To output a Scan Control program, press one of the “PROG” buttons numbered from 1 to 12, then set the running parameters. In Direct mode, only one program can be enabled at a time and the program buttons are overriding, i.e. the last one pressed overrides the one already enabled. To switch off the program, press the “PROG” button with its LED lit (the LED shows which program’s enabled).

7.1.1 Program elements

Every Scan Control program can work on all the available parameters or just some of them. Operators can in fact decide how many SCENES make up the program (from 1 to 12), which units to use (from 1 to 12) and which of the individual fixtures' effects are to be used. When one of the PROG buttons is pressed and held down, the following appears on the display:

```
-----SELECT UNIT-----
select active scenes/units/effects
```

The enabled scenes are indicated by the green LEDs that are lit: if none are lit, the program can't be created. The enabled units are also shown by lit LEDs: if none are lit, it will seem that the program isn't running. For each individual UNIT, the "effects" to be run in the program being created must be specified: in this sense, everything is considered an "effect"; from Pan and Tilt to the Dimmer and so on. When creating a program, any effects which haven't been enabled won't be controlled. To add a Scan Control program to a Memory Register, the same is done in REG mode (see 7.6) as in DIRECT mode (for the creation of programs and for direct use).

7.2 Groups of units

The GROUP function is automatically enabled by pressing and holding down one of the UNIT buttons.

The following message appears on the display:

```
SELECT OTHER UNITS TO MAKE A GROUP
000 000 000 000 000 000
```

By pressing the buttons of other units, (the LEDs of the relative buttons start flashing), a group is created.

Scan Control can only control one group of units, which must all be of the same type.

When the units forming a group have different parameter values, these are replaced on the

```
FUNC
***
```

display by three asterisks: . These will be replaced by the numerical value when the effect is latched on all the units; i.e. when the value of the DMX channel is reached.

Different units in a group are only "uncontrollable" as far as effects are concerned, whereas for scanners and moving head fixtures (those with Pan and Tilt) it's possible to use a group with different fixtures (e.g. Galileo scanners with Victory scanners), to run mirror or head movements simultaneously.

Any movement differences will obviously depend on the relative fixtures' electromechanical characteristics.

Only a single unit or one group of units can be controlled manually.

7.3 Movement effects

Scan Control has some dedicated factory programmed movement effects for scanners and moving head fixtures.

Using these powerful controls, highly effective animated cues can be created with just one command, and it's also possible to use them when creating programs, with the considerable advantage of realising a complete animated cue in a single scene.

Once a unit (e.g. a scanner) has been selected, scrolling with the right-hand SCROLL button gives access to the page dedicated to these functions. The following appears on the screen:

SHAPE	X_SCL	Y_SCL	SPEED	ROTAT	ANG
fisso	---	---	---	---	---

Shapes available at present are Circle, Square, Diagonal 1, Diagonal 2, Angles, Inf.ty, Zigzag.
Parameters at operators' disposal at present are:

- X_SCL: scale on the X axis (from 0 to 100%)
- Y_SCL: scale on the Y-axis (from 0 to 100%)
- SPEED: speed at which the effect is run (from 0 to 255)
- ROTAT: direction of movement (normal or inverse)
- ANG: starting angle of the movement (from 0 to 359).

By using the scale and speed parameters, the initial figures can be deformed, thus creating others.

Fixtures using effects controlled via the joystick or the cursors cannot be positioned: the movement effects in fact operate on the entire scanning area. To run an effect in any given point, the SCANNING AREAS must be used (see parag. 7.5.3). When running the same effect on several scanners, using the ANG parameter allows to create spectacular "chase" effects: this parameter in fact creates a delay between the various fixtures which visually appears as a delay time in running the movements. Some movement effects achieve the maximum spectacularity when the fixtures used are installed in a regular or symmetric layout.

7.4 Use in Reg mode

In the same way as the Light Chase Control section, Scan Control can also be used in two modes: Direct (see 7.1) and Reg.

Reg mode operates directly on the memory registers and allows to carry out the necessary variations directly in the register without having to reconstruct the register's entire contents (which as we already comprise dimmer channels, chases and programs). This is possible thanks to the logic software used: the memory register's components operate together in the register, but can be separately modified, as they are separate "entities".

It's therefore possible to modify the running times of a program added to a Memory Register by



just latching it to the REG command: just press the  button and hold it down. One of the 24 Memory Register LEDs will flash, showing that the operator is using that particular register. To select another, just press the relative button.

In this way, running parameters (Rate, Speed, Music and Bckward) can be modified and it's also possible to decide which fixtures and effects to use in that particular register. Selection is carried out in the same way as in DIRECT mode (see 7.1.1.). A program can be added to several memory registers with all the required variations: it's thus possible to have the same number of variations as there are memory registers available.

The only limit is in the program's essence: if a scene is modified, all the registers will have the scene modified. A scene realized with certain effects is therefore the essence of the program and if it's decided to leave out a scene in register X, the program isn't modified, only how it runs.

7.5 - The Utilities

To facilitate operators' work to the utmost, some functions have been grouped together in menus,



which can be accessed by pressing the  button. The fundamental utilities will appear on the

display and can be scrolled by pressing the SCROLL buttons on the right of the display.

7.5.1 Remote lamp ignition

If the fixtures used allow it, this utility enables fixtures' lamps to be switched on and off extremely easily.



After pressing the button, scroll with the SCROLL buttons until the following appears:

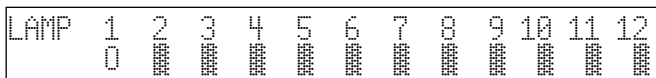

where the black dot indicates the lamp which is lit (and the UNIT's LED is also off in this case). Switching discharge lamps on and off frequently can jeopardise their life, so it's advisable to do so only when strictly necessary.

7.5.2 Remote fixture reset

If the fixtures used allow it, this utility enables to send them the Reset command, often indispensable to restore control of fixtures which run wild due to the DMX chain being subject to undesirable impulses.



After pressing the button, scroll with the SCROLL buttons until the following

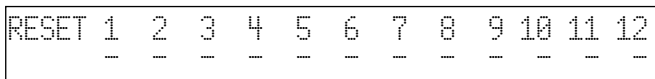

appears: . To run a reset, just press the fixture's button briefly. When the Reset command is being sent, a capital R appears on the display instead of the hyphen.

7.5.3 Operating areas

Operators often have to limit a fixture's scanning area, for example to illuminate a proscenium without lighting the front row of the stalls, or to adapt stored programs to stage situations, which often change.

With a view to this, Scan Control allows to control the 12 different scanning areas for each fixture (obviously only scanners and moving head units) which operators have at their disposal.



After pressing the button, scroll with the SCROLL buttons until the following appears:

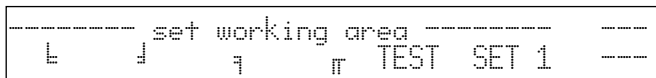

and press one of the fixture buttons.

To assign one of the available scanning areas, scroll with the fader under the "SET 1", until the required one is reached. To check if the area meets requirements, the dark grey corresponding to "TEST" is pressed (the message flashes) and the scanning area tested by moving the joystick.

To modify the scanning area, press the dark grey button under the small corner symbols (L, J, 7, R), then move the joystick to the required new corner. When the required position is reached, the new corner is memorized by pressing the button again.

Operating areas can be created as required, without being obliged to form regular shapes, as shown in the design alongside.

There's no command for resetting a operating area once it's been set, but to do so the 4 corners are selected and the co-ordinates shown in the design alongside entered: 0.0 - 999.0 - 999.999 - 0.999.

Reducing the scan area of a fixture also considerably improves the precision of moving parts, whether they're mirrors or heads. In fact, reducing the scanning area doesn't reduce the number of steps for positioning, which remains unchanged (255 for 8-bit fixtures and 65.536 for 16-bit fixtures). If the fixtures being controlled don't have commands for automatic inversion of scanning co-ordinates, (to facilitate positioning fixtures mounted opposite each other), the Scan Control scanning areas allow to solve the problem by simply setting the corner values crossed over (e.g. setting corner 0.0 as 999.0 and vice versa).

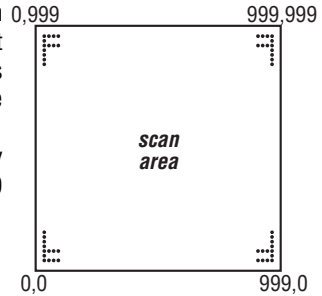

7.6 - Creating a program

As already said, Studio Scan Control has 12 programs for intelligent fixtures, each made up of a maximum of 12 scenes.

To create a new program or modify one which already exists,

direct



press the  button: these operations are only possible in this operating mode.

Pressing one of the PROG buttons (numbered from 1 to 12) gives access to the required program.

To create or modify scenes, use the buttons numbered from 1 to 12 in the SCENE area: pressing on gives access to the required scene.

In this situation, buttons 1-12 of the UNIT zone allow to set the required values for each individual fixture controlled.

For each program, operators can decide how many and which scenes it has, which fixtures work in the program and which of the controlled fixtures' effects accept the commands sent by the Scan Control.

Once this preparatory phase is completed, to create the scenes in the program, just press the button of the scene to be prepared, then press (singly or in groups) the buttons of the fixtures and enter the required parameters.

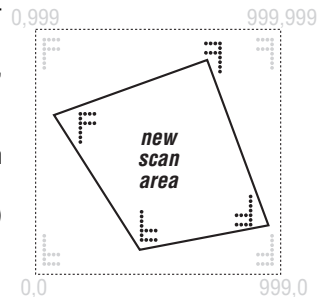

store



When the scene is complete, press the  button to store it and then (keeping it pressed down) press the button of the current scene.

7.6.1 - Copying a scene

store



To copy the contents of one scene to another, press the button of the "origin" scene, then and (holding it down) press the button of the "target" scene.

7.6.2 - Copying a program

To copy the contents of one program to another, press the button of the “origin” program, then



and (holding it down) press the button of the “target” program.

7.6.3 - Adding a Program to a Memory Register

Adding a program to a Memory Register is a very simple procedure: once the program has been



selected and running parameters set, press the button, then (holding it down) press the button of the required Memory Register.

Any variations required later can be carried out in REG mode (see 7.3).

Storage can be carried out in two ways:

from DIRECT MODE to the Memory Register with the procedure already shown: this is the easiest method, as it can be carried out directly from the moment in which a program has what seem to be the ideal characteristics for running (and therefore for output); from REG mode to the Memory Register, creating the possible scene/unit/effect combinations on each occasion and entering the required running settings (speed, rate, music and backward).

8 - Setup functions



By means of the Setup menu, accessed by pressing the button, access is gained to the Studio 24 Scan Control's numerous functions.

8.1 - Addressing light channels

This function has two fundamental aims: deciding which are the DMX channels corresponding to the faders in the dimmer channel section and also carrying out multiple patches.

As already said, patching procedure allows to assign the control of DMX channel n to a given fader. Scan Control allows to link several DMX channels to one fader, so the fader chosen will control channels n1, n150, n320...

This is very important when operating (for example) in television (broadcasting) applications, in which quantities of channels are used to create the background white light.

Once access is gained to Setup, the following appears on the display:

```
CONFIGURATION & SET UP
SELECT --> [DIMMER PATCH ] ok->
```

For access to these settings, just press the right-hand arrow of the SCROLL buttons (on the right of the display):

```
DMX-CH CHANNEL LIM% EQUAL ok->
[001] <---- - - - - <DEL>
```

DMX-CH indicates the "physical" dimmer channel of the DMX chain (from 1 to 512); CHANNEL indicates which dimmer channel on the desk will control the chosen channel or channels; LIM% indicates any attenuation on that channel; EQUAL indicates the equalization curve allocated to the channel.

Pressing the dark grey button under the display corresponding to , settings carried out are cancelled.

8.1.1 - Equalization curves

Use of the equalization curve optimizes luminous output when using fixtures with different types of lamps (e.g. theatrical fixtures and PAR 64).

There are 6 curves (from 1 to 6), linear output (N° 7) and the On/Off step (N°8), which has the following reference values:

$$000 \div 127 = \text{off}$$

$$128 \div 255 = \text{on.}$$

8.2 - Addressing the fixtures

In the same way as the Light Channels, the units in the Scan Control section must be addressed. Access to this function is gained using this menu:

```
CONFIGURATION & SET UP
SELECT --> [UNIT PATCH ] ok->
```

Pressing the right arrow of the SCROLL buttons, access is gained to the setting menu:

```

UNIT   TYPE           FROM -100 1--cod--10
[ 1 ] VICTORY 2 <DEL> TO -111 " " " " " "

```

To assign the parameters, the CURSOR arrows can be used (up and down increase/decrease the values, left and right move from function to function).

In the example above, unit 1 is an SGM Victory II 250, whose start address has been set at 100.

Scan Control will automatically calculate the last channel required for that fixture and on the right-hand side of the display show the configuration to be set on the dip-switches on the rear of the fixture.

In this case, the convention adopted means that the ON position on the dipswitch is that in which the small black square appears at the top.

Here again, pressing the button corresponding to cancels previous settings.

Operators are not limited to assigning numerically increasing addresses to the units (e.g. 100 for unit 1 and 125 for unit 2), but can use the 12 units at their disposal as they wish.

Press one of the SCROLL buttons again to exit the function.

8.3 - Changing the language used

This function is used to set all the messages on the display in one of the two languages available: English or Italian.

Access is gained from the following menu:

```

          CONFIGURATION & SET UP
SELECT --> [CHANGE LANGUAGE   ]  ok->

```

The cursor's up/down buttons are used for selection.

8.4 - Available memory

The desk has two memory areas, one for the unit libraries and the other for the memory used for Event Recording (see chapter 10).

The maximum number of units in the library only depends on the quantity of memory at operators' disposal. Access is gained from the following menu:

```

          CONFIGURATION & SET UP
SELECT --> [VIEW FREE MEMORY   ]  ok->

```

Once in the menu, this type of message will appear:

```

FREE MEMORY (bytes):
RECORD: 98228 LIBRARY: 62154  ok->

```

, in which the exact amount of memory available is shown. Deleting unnecessary records or fixtures which are not being used (inadvisable) will free memory for new registering or new units.

8.5 - Built-in memory

This memory, made up of 3 sections, is a fundamental part of the Scan Control's "brain": this is where the units which are to be controlled are created, modified or cancelled from the built-in memory.

Access is gained from the following menu:

```
CONFIGURATION & SET UP
SELECT --> [INTERNAL LIBRARY ] ok->
```

8.5.1 - Creating a new unit

Operators can use this function to enter units any units the library doesn't already contain.

ATTENTION! Before proceeding with the creation of a new unit, make certain to have all the necessary information or better still, its instruction manual with all the informative tables.

Now, proceeding step by step through the entering of the required parameters, a new unit can be ready for use in just a few minutes.

The initial menu is the following:

```
--- INTERNAL LIBRARY CONFIGURATION ---
Select ITEM --- [CREATE NEW UNIT ]
```

Access is gained to the library by pressing the right-hand SCROLL button.

N.B. To simplify menu examples, we shall create an SGM Victory II 250 as a new fixture.

8.5.1.1 - DMX channel total

This information allows Scan Control to know how many channels new units use. As already seen, the maximum number possible is 36 channels, of which 6 are reserved for movement and auxiliary functions.

The menu is the following:

```
Select feature to configure for   esc<-
NNNNNNNNNNNNNN--[TOTAL DMX CHANNEL ] ok->
```

Pressing the right-hand arrow gives access to the setting, by pressing the left-hand button, the function is exited.

```
Total channels occupied on dmx   esc<-
NNNNNNNNNNNNNN-- [12]          ok->
```

The display will show

Using CURSOR up/down arrows, operators can increase the number of channels required for the new unit. The choice is confirmed by pressing the right-hand SCROLL.

8.5.1.2 - LCD effect labels

This menu allows descriptions of the commands required by the new unit to be written on the LCD. The menu is the following:

```
Select feature to configure for   esc<-
NNNNNNNNNNNNNN--[LCD EFFECT LABEL ] ok->
```

Pressing the right-hand arrow gives access to the setting, by pressing the left-hand button, the function is exited.

```

Enter number of LCD pages          esc<-
NNNNNNNNNNNNNN--                [2]   ok->

```

The display will show

Using the CURSOR up/down arrows (or the right-hand fader of the row under the display), operators can increase the number of pages required to view all the unit's effects on the display. Continuing with our example (the Victory II 250), 2 pages are necessary: the unit in fact has 12 channels, 4 of which are reserved for Pan and Tilt and 1 for Remote Reset, so 7 remain for the effects, which will be divided by 6 (the effects which can be allocated to each menu), thus obtaining the result of 2 pages.

OK (the right-hand SCROLL) confirms, after which it's possible to create the menus:

```

Enter the string for effects      more<->
-----                          P1

```

The up/down CURSOR arrows are used to scroll through the set of characters available, left/right to pass from letter to letter, pressing the right-hand SCROLL gives access to page 2 and the left-hand SCROLL returns to the pervious menu.

```

Enter the string for effects      more<->
DIMMR COLOR PALET GOBOS ROT.G SHUTR P1

```

In this case: and then

```

Enter the string for effects      more<->
PRISM ----- P2

```

Press the left-hand SCROLL to return to the creation menu now. Storage is automatic.

8.5.1.3 - Internal addressing

This part of the instructions regards addressing functions to fixtures' physical channels. When carrying out internal addressing, operators do not necessarily have to access assignment in numerical order (i.e. there is no need to follow the order of 1, 2, 3, ...), so effects can be used are required. The menu is the following:

```

Select feature to configure for   esc<-
NNNNNNNNNNNNNN--[INTERNAL PATCH ] ok->

```

Pressing the right-hand arrow gives access to the setting and pressing the left-hand button the function is exited.

Once OK (right-hand SCROLL) has been pressed, the effect string created in 8.5.1.2 will reappear; the following menu appears:

```

DIMMR COLOR PALET GOBOS ROT.G SHUTR <->
[ 1]  --  --  --  --  --  P1

```

Use the CURSOR up/down arrows to set the value, left/right to pass from effect to effect, press the right-hand SCROLL to go to page 2 and the left-hand SCROLL to return to the pervious menu.

```

DIMMR COLOR PALET GOBOS ROT.G SHUTR <->
[ 1]  2  8  3  7  4  P1

```

In this case: and then

```

PRISM ----- <->
[ 9]  --  --  --  --  --  P2

```

Press the left-hand SCROLL to return to the creation menu now. Storage is automatic.



8.5.1.4 - Standby values

This menu is used to set the parameters which must be sent to the fixtures when they are not involved in a scene or used manually.

It's very important to set these values, particularly when operating with fixtures fitted with discharge lamps, whose shutters have to be closed to avoid unwanted illumination, or for those with halogen lamps, for which, as well as closing the shutter, output can be lowered by dimming the light. The menu is the following:

```
Select feature to configure for      esc<-
NNNNNNNNNNNNNN--[STAND-BY VALUES ] ok->
```

. Press the right-hand arrow to access setting and the left-hand button to exit the function.

Once OK (right-hand SCROLL) has been pressed, the effect string created in 8.5.1.2 will reappear: the following menu appears:

```
DIMMR COLOR PALET GOBOS ROT.G SHUTR  <->
[ - ]  --  --  --  --  --  P1
```

. Use the CURSOR up/down arrows to set the value, left/right to pass from effect to effect, press the right-hand SCROLL to go to page 2 and the left-hand SCROLL to return to the previous menu.

```
DIMMR COLOR PALET GOBOS ROT.G SHUTR  <->
[000]  ---  ---  ---  ---  000  P1
```

In this case: and then

```
PRISM  -----  <->
[---]  ---  ---  ---  ---  ---  P2
```

These settings therefore indicate that when the scanner is not being used the dimmer must be at 0 and the shutter closed.

Press the dark grey button corresponding to the string on the display: it's possible to set an "indeterminate" condition, i.e. the value "none" corresponding to three dashes (---).

Press the left-hand SCROLL to return to the creation menu now. Storage is automatic.

8.5.1.5 - Type of effect

This menu is used to decide which of the new fixture's functions are effects and which are dimmers. Dimmer functions will always be subjected to the action of the fader: this allows a program assigned to a Memory Register to "come up" gradually, along with the other luminaires controlled by the desk. The menu is the following:

```
Select feature to configure for      esc<-
NNNNNNNNNNNNNN--[EFFECTS TYPE ] ok->
```

. Press the right-hand arrow to access setting and the left-hand button to exit the function.

Once OK (right-hand SCROLL) has been pressed, the effect string created in 8.5.1.2 reappears and the following menu appears:

```
DIMMR COLOR PALET GOBOS ROT.G SHUTR  <->
[EFF]  EFF  EFF  EFF  EFF  EFF  P1
```

. Use the CURSOR up/down arrows to set the value, left/right to pass from effect to effect, press the right-hand SCROLL to go to page 2 and the left-hand SCROLL to return to the previous menu.

```

DIMMR COLOR PALET GOBOS ROT.G SHUTR  <->
[DIM]  EFF  EFF  EFF  EFF  EFF  P1

```

In this case:

and then

```

PRISM ----- <->
[EFF] --- --- --- --- --- P2

```

These settings therefore indicate when the channel of the dimmer function must be considered as such (DIM) and when it must be considered as an effect (EFF).

Press the left-hand SCROLL to return to the creation menu now. Storage is automatic.

8.5.1.6 - Mirror/Head

This menu is used to set the channels dedicated to the movement of mirrors and moving heads. Numerous fixtures allow 8 and 16 bit control, others only 8 bit. As already said in previous chapters, 16-bit movement gives a better quality movement. However, since DMX standard requires that each channel is assigned with a value of between 0 and 255, two channels (operating together) are required for the higher resolution, so the value range is between 0 and 65.536.

In 16-bit mode the two channels (e.g. those for Pan) will have two special functions, called Least Significant Byte (LSB, L or Fine) and Most Significant Byte (MSB, H or Coarse).

In 8-bit mode, just one channel is used (e.g. that of the Pan), so only the MSB (H) parameter is set, leaving the LSB indeterminate (—).

Remember to check if the fixture to be controlled is operating in 8 or 16 bit mode!

The following menu appears:

```

Select feature to configure for      esc<-
NNNNNNNNNNNNNN--[MIRROR/HEAD PATCH ] ok->

```

Press the right-hand arrow to access setting and the left-hand button to exit the function: the following appears on the

```

X(PAN)      | Y(TILT)      | MIRROR/HEAD
H[---]L --- | H --- L --- | OUTPUT      ok->

```

display: Use the CURSOR up/down arrows to set the value, left/right to pass from parameter to parameter and the right-hand SCROLL to return to the previous menu.

```

X(PAN)      | Y(TILT)      | MIRROR/HEAD
H[ 5]L 11   | H 6 L 12    | OUTPUT      ok->

```

In this case: if we want to use the Victory in 16-bit mode (advisable), or

```

X(PAN)      | Y(TILT)      | MIRROR/HEAD
H[ 5]L ---  | H 6 L ---   | OUTPUT      ok->

```

if it's to be used in 8-bit mode.

Press OK (right-hand SCROLL) to return to the previous menu.

8.5.1.7 - Slope Speed

This menu is used to set the speed with which the fixture passes from one effect to another. This "run" can be HARD, i.e. taking place at the fastest possible speed, or SOFT, i.e. linked to the time set using the SPEED potentiometer in the Scan Control section. The following menu appears:

```

Select feature to configure for      esc<-
NNNNNNNNNNNNNN--[HARD/SOFT CROSS ] ok->

```

Press the right-hand arrow

to access setting and the left-hand button to exit the function.

Once OK (right-hand SCROLL) has been pressed, the effect string created in 8.5.1.2 reappears: the following menu appears:

```
DIMMR COLOR PALET GOBOS ROT.G SHUTR <->
[HARD] HARD HARD HARD HARD HARD P1
```

. Use the CURSOR up/down arrows to set the value, left/right to pass from effect to effect, press the right-hand SCROLL to go to page 2 and left-hand SCROLL to return to the previous menu.

```
DIMMR COLOR PALET GOBOS ROT.G SHUTR <->
[SOFT] SOFT HARD SOFT SOFT HARD P1
```

In this case: and then

```
PRISM ----- <->
[HARD] --- --- --- --- --- P2
```

These settings therefore indicate that the channel of the dimmer function, the gobos and their rotation and the prism and its rotation must operate in SOFT mode, whereas the filter holders and shutter operate in HARD mode.

Press the left-hand SCROLL to return to the creation menu now. Storage is automatic.

Operators can have two versions of the same fixture in the library, one with SOFT settings (more suited to live applications) and the other HARD (better for clubs).

8.5.1.8 - Unit name

This menu is used to give new units a name, for which operators have a complete set of upper and lower case characters and symbols at their disposal.

The following menu appears:

```
Select feature to configure for      esc<-
NNNNNNNNNNNN--[UNIT NAME           ] ok->
```

. Press the right-hand arrow to access setting and the left-hand button to exit the function.

The following menu appears:

```
ENTER/MODIFY THE NAME OF THE UNIT
-NNNNNNNNNNNN-
```

. Use the CURSOR up/down arrows (and the right-hand fader under the display) to choose the letters, left/right to pass from letter to letter and press the left-hand SCROLL to return to the previous menu.

```
ENTER/MODIFY THE NAME OF THE UNIT
-VICTORY2 TST-
```

In this case:

8.5.1.9 - Remote and lamp reset values

This menu is used to set the parameters which allow the fixture to carry out (when it has the capacity) Remote Reset and Remote lamp on/off.

These settings will be used by the Scan Control for the functions which operators can access with the UTILITY function (parag. 7.4.1 and 7.4.2) (Remote Reset and Remote Lamp On/Off).

The following menu appears:

```
Select feature to configure for      esc<-
VICTORY TST --[RESET/LAMP VALUES ] ok->
```

. Press the right-hand arrow

to access setting and the left-hand button to exit the function.

Once OK (right-hand SCROLL) has been pressed, the following menu appears:

```

RESET  OFF   ON   | LAMP  OFF   ON
[  -- ]  ---  ---  |  ---  ---  ---  ok->
    
```

Use the CURSOR up/down arrows to set the value and the right-hand SCROLL to confirm the choice and return to the previous menu.

```

RESET  OFF   ON   | LAMP  OFF   ON
[10]  234  255  |  --  ---  ---  ok->
    
```

In this case:

These settings therefore indicate that the Remote Reset channel operates on channel 10 and runs a reset when values of between 235 and 255 are sent.

Some fixtures require the action of a virtual reset, similar to that of cut-off switches after they trip: before turning these switches on again, their protections must be reset. This is why a single value is not given for this operation, but a range from a minimum to a maximum, outside of which there's no reset (Off), and therefore the value of real tripping is indicated (Off). All these operations are carried out by the desk itself when the parameters are set and run in the aforementioned UTILITIES.

Press the right-hand SCROLL to return to the creation menu now. Storage is automatic.

8.5.1.10 - Dip-switch configuration

This menu is used to enter the data that allow the Scan Control to show the exact configuration of the dipswitch for addressing the units during unit assignment procedure (see 8.2). If the new unit does not have a dipswitch, but a built-in microcomputer, these settings can be omitted. The following menu appears:

```

Select feature to configure for   esc<-
VICTORY TST --[DIP-SWITCH CONFIG.] ok->
    
```

Press the right-hand arrow to access setting and the left-hand one to exit the function. Once OK (right-hand SCROLL) has been pressed, the following menu appears:

```

ENTER THE DIP-SWITCH CONFIGURATION
n.dip=[ 9] 1st channel= 0  ok->
    
```

Use the CURSOR up/down arrows to set the value, the left and right-hand ones to pass from parameter to parameter and the right-hand SCROLL to confirm the choice and return to the previous menu. The number of switches (n.dip) which make up the dipswitch section indicates which type of component the fixture's manufacturer has used.

The dipswitch enters addresses in binary logic, summing all the values shown by the switches set

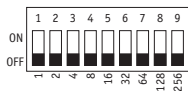

at ON:

There are two ways of using this addressing system: the first uses a pure binary system, whereas the second automatically adds a 1 to the address. We shall therefore indicate if the FIRST CHANNEL has a value of 1 or 0. Addressing changes according to the two examples of fig. 1

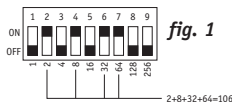

(pure binary) and fig. 2 (1+ binary): Both systems are used by manufacturers throughout the world and in practical terms, they differ in the fact that in the pure binary system the address has a value of 1 if the switch is at ON, whereas in the “1+binary” mode, the address has a value of 1 if all the switches are at OFF.

8.5.1.11 - Beam search values

This menu is used by operators to set new units' control channels' conditions for use when carrying out the procedure for defining the operating area. Many scanners and moving head fixtures are fitted with diaphragms or systems for reducing the dimension of the output beam and these can be used to advantage for the best definition of the fixtures' operating areas.

The following menu appears:

```
Select feature to configure for      esc<-
VICTORY TST --[BEAM FIND VALUES ] ok->
```

Press the right-hand arrow to access setting and the left-hand one to exit the function.

Once OK (right-hand SCROLL) has been pressed, the effect string created in 8.5.1.2 will reappear: the following menu appears:

```
DIMMR COLOR PALET GOBOS ROT.G SHUTR  <->
[ - ]  --  --  --  --  --  P1
```

Use the CURSOR up/down arrows to set the value, left/right to pass from effect to effect, press the right-hand SCROLL to go to page 2 and the left-hand SCROLL to return to the previous menu.

```
DIMMR COLOR PALET GOBOS ROT.G SHUTR  <->
[200]  ---  ---  135  ---  255  P1
```

In this case: and then

```
PRISM ----- <->
[---]  ---  ---  ---  ---  P2
```

These settings therefore indicate that in “beam search” status we want the light to be slightly lower than maximum, with gobo 6 (small circle) and the shutter open.

Press the left-hand SCROLL to return to the creation menu now. Storage is automatic.

8.5.1.12 - Type of control

This menu is used to choose one of the two options available for using fixtures' effects. Many models on the market have continuous colour and gobo wheel rotation (analog functions), which enables operators to obtain interesting projection effects, but during programming, it's often more important to be able to latch a certain colour or effect immediately.

The types of control available are Linear (LIN) and Tabular (TAB): the former enables to scroll through the parameters using the programmed slider, the latter also assigns the up/down CURSOR buttons the direct passage to the “centre value” of an effect. This means that if a certain gobo is projected using values 120 to 139, it will be perfectly centred in the projection area at

132. This value will be entered in a table and can be easily reached using the controls as already explained. The use of the tables requires a more memory when adding new units to the library (see parag. 8.4).

The following menu appears:

```
Select feature to configure for      esc<-
VICTORY TST --[CONTROL TYPE       ] ok->
```

. Press the right-hand arrow

to access setting and the left-hand one to exit the function.

Once OK (right-hand SCROLL) has been pressed, the effect string created in 8.5.1.2 will appear: the following menu appears:

```
DIMMR COLOR PALET GOBOS ROT.G SHUTR <->
[LIN] LIN  LIN  LIN  LIN  LIN  P1
```

. Use the CURSOR up/down

arrows to set the value, left/right to pass from effect to effect, press the right-hand SCROLL to go to page 2 and the left-hand SCROLL to return to the previous menu.

```
DIMMR COLOR PALET GOBOS ROT.G SHUTR <->
[LIN] LIN  LIN  TAB  LIN  LIN  P1
```

In this case:

and then

```
PRISM -----<->
[LIN] --- --- --- --- --- P2
```

These settings therefore indicate that tabular control will only be used for the gobo channel.

To set the tables' parameter, press the dark grey button below where GOBOS is printed. The following will appear on the display:

```
PAGE 1  TOT. ITEM  ITEM VALUE
EFFECT_1 [ 1]      1      0 ok->
```

"Tot. Item" are intended as the number of parameters to enter in the table (maximum 50). Press the right-hand CURSOR button to decide which ITEM to change and then what VALUE to enter for that index.

Continuing with the example of the Victory II 250, the following appears:

```
PAGE 1  TOT. ITEM  ITEM VALUE
EFFECT_1 [13]      1      0 ok->
```

```
PAGE 1  TOT. ITEM  ITEM VALUE
EFFECT_1 [13]      2     25 ok->
```

```
PAGE 1  TOT. ITEM  ITEM VALUE
EFFECT_1 [13]      3     45 ok->
```

```
PAGE 1  TOT. ITEM  ITEM VALUE
EFFECT_1 [13]      4     65 ok->
```

```
PAGE 1  TOT. ITEM  ITEM VALUE
EFFECT_1 [13]      5     85 ok->
```

```
PAGE 1  TOT. ITEM  ITEM VALUE
EFFECT_1 [13]      6    105 ok->
```

```
PAGE 1  TOT. ITEM  ITEM VALUE
EFFECT_1  [13]      7  125 ok->
```

```
PAGE 1  TOT. ITEM  ITEM VALUE
EFFECT_1  [13]      8  145 ok->
```

```
PAGE 1  TOT. ITEM  ITEM VALUE
EFFECT_1  [13]      9  165 ok->
```

```
PAGE 1  TOT. ITEM  ITEM VALUE
EFFECT_1  [13]     10  180 ok->
```

```
PAGE 1  TOT. ITEM  ITEM VALUE
EFFECT_1  [13]     11  198 ok->
```

```
PAGE 1  TOT. ITEM  ITEM VALUE
EFFECT_1  [13]     12  218 ok->
```

```
PAGE 1  TOT. ITEM  ITEM VALUE
EFFECT_1  [13]     13  255 ok->
```

Press the right-hand SCROLL to return to the previous menu. Storage is automatic.
Press the left-hand SCROLL to return to the creation menu now. Storage is automatic.

8.5.2 - Error messages

If the procedure for creating a new fixture is carried out successfully, no particular message will appear on the display and operators can continue addressing work and use of the new fixture. If any mistakes are made or any steps forgotten when creating new units, the display will show a message like this:

```
CONFIGURATION MISHMASH!          esc<-
Do you want to exit or retry ?  retry->
```

Press the right-hand SCROLL button to see all the parameters again and correct the incorrect data: press the left-hand button to abort the session for creating the new unit, obviously losing all the work done up until then.

When changes are made to a unit that already exists, the following appears on the display:

```
UNIT X      -ALREADY EXISTS !      quit<-
Do you want to replace it ?  <no> yes->
```

Press YES to confirm the modification to the existing unit, NO (the dark grey button corresponding to the message) to return to the main menu and QUIT to return to parameter modification procedure.

When the whole available memory is used, if the user try to insert a new unit will appear:

```
THERE IS NOT ENOUGH SPACE IN RAM !
                                           ok->
```

It is possible to free more memory deleting old or unused units from the library (see 8.5.4).

When <OK> is pressed the error message disappear.

La differente gestione della memoria per gli “Event Recording” (capitolo 10) non segnala con messaggi la mancanza di spazio: in questo caso si fermerà automaticamente la registrazione (cfr. 10.2).

8.5.3 - Modifying a unit in the library

This option allows operators to modify the parameters of units already in the library.

This procedure is carried out as explained in parag. 8.5.1 and sub-paragraphs.

Messages which may appear on the display are those already described in parag. 8.5.2.

The function is accessed from the following menu:

```
--- INTERNAL LIBRARY CONFIGURATION ---  
Select ITEM --- [EDIT EXISTING UNIT ]
```

Press the SCROLL buttons' right-hand key to access the function.

8.5.4 - Deleting a unit from the library

This option allows operators to delete obsolete or unused units from the Scan Control's library.

This procedure is necessary when there is insufficient space to add new units

This procedure is carried out as explained in parag. 8.5.1 and sub-paragraphs

The messages which may appear on the display are those already described in parag. 8.5.2.

The function is accessed from the following menu:

```
--- INTERNAL LIBRARY CONFIGURATION ---  
Select ITEM --- [DELETE UNIT ]
```

Press the SCROLL buttons' right-hand key to access the function:

```
Select unit to erase from library  esc<-  
[UNIT NAME]                        ok->
```

Press ESC (left-hand SCROLL button) to exit the cancel function or OK (right-hand button) to eliminate the fixture.

9 - Using the connectors

9.1 - Pedal

A twin pedal can be connected to the appropriate connector on the rear. This remote control allows operators to run through the scenes in a page, leaving their hands free for other work. Intended particularly for groups or operators working in theatres who have to synchronise a scene change with the beginning of a piece of music, this doesn't require any further equipment. Refer to page 6 for the connection diagram. The functions available are:

- UP without enabled registers - enables memory register 1. The page must be selected manually.
- UP with a register enabled - steps up 1 position in the memory registers (e.g. from 1 to 2).
- DOWN with a register enabled - steps down 1 position in the memory registers (e.g. from 2 to 1).
- DOWN without registers enabled - enables memory register 24. The page must be selected manually.
- UP and DOWN simultaneously with the registers enabled - switches the registers off.

This pedal can only change registers operating in the (overriding) AND mode.

9.2 - SMPTE socket

This socket is used to connect the console to a sync time code source, which can be used to record a series of events which must take place at a precise moment. This signal is generally used in broadcasting (television productions). It's only an input, as Studio 24 Scan Control consoles don't generate a signal for external use. The SMPTE signal is normally obtained using the MIDI Time Code (from a sequencer, for example) and converting it with one of the numerous devices available for this purpose.

9.3 - MIDI connectors

By means of these connectors, which use a standard recognized throughout the world, it's possible to carry out various operations, the most important of which are:

- linking several Studio consoles to increase the units and programs available;
- connecting a Studio console for use as a 'slave' of a master keyboard or sequencer.

When several consoles are connected in a MIDI chain, the DMX signals aren't summed: each console must be connected to the relative DMX chain.

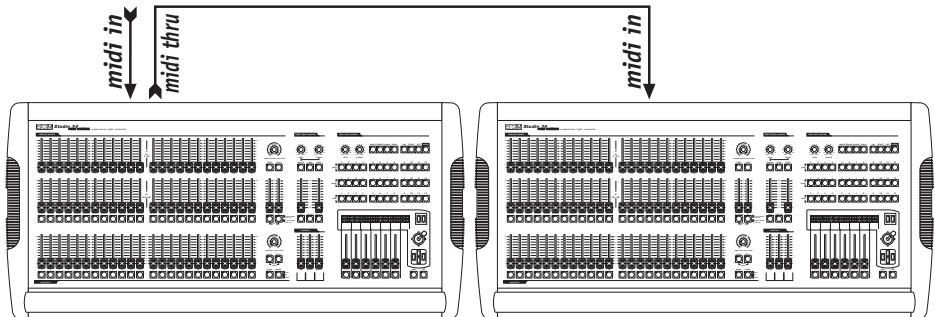

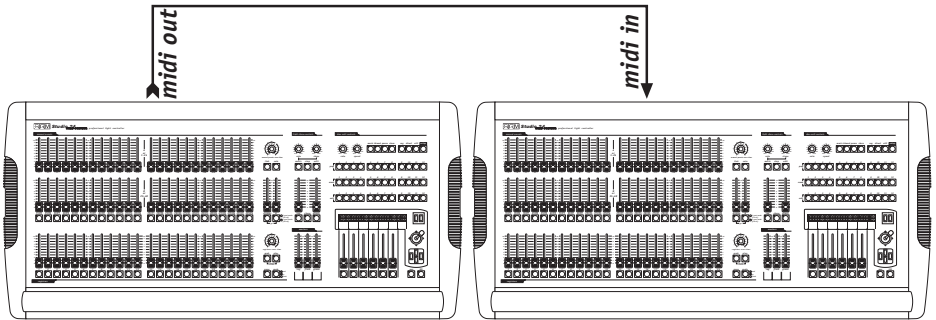

The dipswitch on the rear of the console allows to select the MIDI channel on which the signals sent to the console are received (the MIDI channels have a range of 1 - 16). Commands are only transmitted by the console on channel 1.

The Studio console's software doesn't take into consideration values not within the range required for each function.

The possibility of transmitting MIDI data to other Studio consoles can be used to control other devices using this 'language'. If a sequencer or master keyboard (enabled to receive on channel 1) has to carry out actions co-ordinated with the lights, when a Memory register is enabled the relative Program Change is also sent, so the two events take place simultaneously.

9.3.1 - Midi IN - Note On

This command is used to switch on one or more of the 24 dimmer channels (or 48, according to operating mode) using the MIDI "Note On" command and treating the channel like a key on a piano keyboard. It's therefore virtually possible to "play" the light channels!

The range of values must be between 36 and 83. Values not included in this range are automatically excluded. On a piano keyboard 36 corresponds to C3 (Do in the third octave).

If the device transmitting the MIDI signals is fitted with Velocity control, the channel is switched on at the level indicated by Velocity, if not, it will simply be switched on.

9.3.2 - Midi IN - Note Off

This command allows to switch off one or more of the 24 dimmer channels (or 48, according to the operating mode), using the MIDI "Note Off" command.

The range of values must be between 36 and 83. Values not included in this range are automatically excluded.

9.3.3 - Midi IN - Program Change

This MIDI function allows to change the presets a unit is equipped with. On Studio 24 consoles, transmitting this data allows to pass from one memory register to another. The range of parameters must be between 0 and 23. This value allows to pass from register 1 to register 24. In MIDI numeration, 0 stands for 1, so the correspondence is as follows: 0=1, 1=2, 2=3, 3=4, 4=5, 5=6, 6=7, 7=8, 8=9... 23=24.

The transmission of one of the above values switches the register on and transmitting the same value again switches it off.

9.3.4 - Midi IN - All Channels Off

In MIDI, this command is part of the vast Control Change series (followed by hexadecimal codes 7Bh and 0h) and results in all the channels which were previously on being switched on.

9.3.5 - Midi IN - Bank Select

This function allows to pass from one memory bank to another and on Studio 24 consoles is used to change memory register PAGE.

This command is also part of the vast Control Change series, and is identified by hexadecimal code 0h followed by a number between 0 and 23 (the same indications as in 9.3.3 are valid).

9.3.6 - Midi OUT - Program Change

As seen at 9.3.3 (MIDI IN), if for example another Studio console is connected to the one being used, this allows to send the command for changing the memory register.

The 'slave' console, i.e. the one receiving the commands, must have its memory registers in "AND" or "OR" mode, to ensure they run in the same way. The address is fixed on channel 1.

9.3.7 - Midi OUT - Bank Select

As in paragraph 9.3.5, this command allows to change the page of the slave console, enabling the PAGE function. The address is fixed on channel 1 for this function as well.

9.4 - RS-232 connections

Using a standard DB-9 connector, by means of this connection it's possible to connect a Studio console to a personal computer. It's therefore possible to carry out several functions:

- updating the console's firmware
- remote control of the console.

One PC can control up to 16 Studio consoles, each with its address set using the dipswitch located on the rear of the console.

The protocol used is RS-232, which is a 2-way serial data transmission system and therefore only requires one connector. The command format includes the command and one or two numbers between 0 and 127.

Always remember that numeration starts at 0, whereas counting normally starts at 1. This means that if data has to be transmitted to channel 1, it must actually be transmitted to channel 0.

9.4.1 - RS-232 - Channel On (A1h)

This command allows to switch a channel on at a certain level.

The command syntax is as follows: CH_ON,n,x

where n is the number of the channel and x the value to be set. If the value transmitted is not between 0 and 127, it's ignored.

Example: switch on channel 4 at 50% = CH_ON,3,64.

9.4.2 - RS-232 - Channel Off (A2h)

This command is used to switch off a channel.

The command syntax is as follows: CH_OFF,n

where n is the channel number.

Example: switch off channel 4 = CH_OFF,3.

9.4.3 - RS-232 - All Off (A3h)

This command allows to switch off all channels previously switched on with the Channel On command. There's no operator.

The command syntax is as follows: ALL_OFF

Example: switch off the channels = ALL_OFF.

9.4.4 - RS-232 - Register Change (A0h)

This command is used to pass from one memory register to another.

The command syntax is as follows: REG_CHG,n

where n is the number of the register to be switched on.

Example: switch on register 24 = REG_CHG,23.

If this command is given when the register is already on, the register in question is switched off.

9.4.5 - RS-232 - Page Change (A4h)

This command is used to change the enabled page of the memory registers (PAGE).

The command syntax is as follows: PAGE_CHG,n

Where n is the page number.

Example: go to page 6 = PAGE_CHG,5.

9.4.6 - RS-232 - Device Select (A6h)

This command is used to select which one of the 16 Studio consoles the commands are to be sent to.

Setting is carried out on the console's rear panel, using the relative dipswitch.

The command syntax is as follows: DEV_SEL,n

where n is the identification number of the console to be controlled.

Example: select console 3 = DEV_SEL,2.

10 - Using 'Event Recording'

Studio 24 Scan Control consoles are able to record 24 sequences of events and reproduce them. In order to do this, a time code is required for sync purposes: for this reason, Studio 24 consoles are fitted with a socket for connection to an SMPTE signal generator.

This type of signal is used worldwide, mainly in the (television) broadcasting sector. When an SMPTE signal isn't available, the console generates a similar signal internally and uses it for sync. For the complexity of this type of operation, it was decided to only record changes between memory registers, considering them as 'events', and obviously Page changes.

Procedure for event storage records each action at the moment in which it is carried out (for example enabling a register). Enabling registers in OR, OR and Register and Flash mode requires the storage of 2 events: one for switching on, the other for switching off.

Overriding registers (AND) on the other hand require just one.

The console's available memory limit isn't based on time, but quantity: up to 24.000 events can in fact be recorded and be run in the course of an entire day. Operators are free to operate manually on all the console's sections when events are running.

10.1 - 'Event Recording' operating modes

Recorded events can be used (during playback) in two modes: Single Play and Looping Play.



The  button is used to change this mode, in the same way as with Memory registers, according to the following parameters:

- PLAY button LED off = Single Play
- PLAY button LED on = Looping Play.

In Single Play mode, the selected track is played back from start to finish, whereas in Looping Play mode, once the last event has been run, the console returns to the beginning for and continues to run non-stop until terminated by the operator.

Looping Play mode only uses the built-in signal generator: in this case, the SMPTE signal is therefore "rejected".

10.2 - Creating a track

No matter what operating mode they are to be run in, tracks are created using the same criterion.



By pressing and holding down the

 buttons for at least 4 seconds, use the memory register

buttons to select the 'track' to be recorded.

During the selection phase, the GRAB and PLAY buttons' LEDs will be lit, then GRAB will start to flash and will continue flashing throughout recording. The recording zero (i.e. the beginning) is given at the moment in which the button of the required track is pressed.

It's only possible to record crossovers between the various Memory registers (see paragraph 8), with the relative

crossover, flash and page change times.

There's no way of changing a parameter in the track: if operators make a mistake, they must start again from the beginning.

10.3 - Replaying a track

To replay a recorded track, no matter in what operating mode it's to be run in, press the PLAY button and hold it down, then (using the Memory registers' buttons) select the required 'track'.

11 - Advanced use of the Studio 24 Scan Control

In this section, some easy ways for increasing the possibilities offered by the Studio console's Scan Control section are discussed.

NEVER try to create new units or multiple units without first having all the data regarding the units to be created or modified!

11.1 - Multiple units

As has already been seen, each Scan Control can control 12 fixtures using up to 36 channels. There are at present no intelligent fixtures on the market requiring this number of channels: the SGM Galileo IV Live 1200 (at present the most powerful in the SGM range) in fact only uses 18.

Considering that the console operates on all 512 DMX channels, it's possible to exploit the 36 channels available by creating multiple units, i.e. units made up of more than one fixture.

This programming must be carried out carefully, particularly when setting the fixtures' addresses.

To give a practical example: we've 15 SGM Flasher DMX 1.5 units at our disposal to enter among the units already available.

Using the normal method, the 12 units controlled by the console would not be sufficient but, by analysing the Flashers, it can be seen that they only use 2 channels, for the dimmer and flash rate respectively.

It's therefore possible to create a multiple unit made up of the 15 fixtures, but in this case, the assignment of the addresses to be set on the fixtures must be in rising order, starting with the first fixture and addressing them as follows:

- Flasher #1 001 - Flasher #2 003 - Flasher #3 005
- Flasher #4 007 - Flasher #5 009 - Flasher #6 011
- Flasher #7 013 - Flasher #8 015 - Flasher #9 017
- Flasher #10 019 - Flasher #11 021 - Flasher #12 023
- Flasher #13 025 - Flasher #15 027

In the following example, the effects of the 15 fixtures will be set to run in sequence.

We can therefore create a new "Super Flasher" unit, setting the parameters in this way (for a detailed description, see parag. 8.5.1 and sub-paragraphs):

- Channels used:

```
Total channels occupied on dmx      esc<-  
NNNNNNNNNNNNNNNN--                [30]      ok->
```

- Description of the commands on the Scan Control display:

```
Enter the string for effects      more<->  
DIM01 RAT01 DIM02 RAT02 DIM03 RAT03 P1
```

```
Enter the string for effects      more<->  
DIM04 RAT04 DIM05 RAT05 DIM06 RAT06 P2
```

```
Enter the string for effects      more<->  
DIM07 RAT07 DIM08 RAT08 DIM09 RAT09 P3
```

```
Enter the string for effects      more<->
DIM10 RAT10 DIM11 RAT11 DIM12 RAT12 P4
```

```
Enter the string for effects      more<->
DIM13 RAT13 DIM14 RAT14 DIM15 RAT15 P5
```

• Allocation of control channels:

```
DIM01 RAT01 DIM02 RAT02 DIM03 RAT03 <->
[ 1]   2     3     4     5     6     P1
```

```
DIM04 RAT04 DIM05 RAT05 DIM06 RAT06 <->
[ 7]   8     9    10    11    12    P2
```

```
DIM07 RAT07 DIM08 RAT08 DIM09 RAT09 <->
[13]  14    15    16    17    18    P3
```

```
DIM10 RAT10 DIM11 RAT11 DIM12 RAT12 <->
[19]  20    21    22    23    24    P4
```

```
DIM13 RAT13 DIM14 RAT14 DIM15 RAT15 <->
[25]  26    27    28    29    30    P5
```

• Setting for standby parameters:

```
DIM01 RAT01 DIM02 RAT02 DIM03 RAT03 <->
[000] 000   000   000   000   000   P1
```

```
DIM04 RAT04 DIM05 RAT05 DIM06 RAT06 <->
[000] 000   000   000   000   000   P2
```

```
DIM07 RAT07 DIM08 RAT08 DIM09 RAT09 <->
[000] 000   000   000   000   000   P3
```

```
DIM10 RAT10 DIM11 RAT11 DIM12 RAT12 <->
[000] 000   000   000   000   000   P4
```

```
DIM13 RAT13 DIM14 RAT14 DIM15 RAT15 <->
[000] 000   000   000   000   000   P5
```

• Setting for the type of effect:

```
DIM01 RAT01 DIM02 RAT02 DIM03 RAT03 <->
[DIM] EFF  DIM  EFF  DIM  EFF  P1
```

```
DIM04 RAT04 DIM05 RAT05 DIM06 RAT06 <->
[DIM] EFF  DIM  EFF  DIM  EFF  P2
```

```

DIM07 RAT07 DIM08 RAT08 DIM09 RAT09 <->
[DIM] EFF DIM EFF DIM EFF P3

```

```

DIM10 RAT10 DIM11 RAT11 DIM12 RAT12 <->
[DIM] EFF DIM EFF DIM EFF P4

```

```

DIM13 RAT13 DIM14 RAT14 DIM15 RAT15 <->
[DIM] EFF DIM EFF DIM EFF P5

```

- Setting for Mirror/Head (the fixture has no moving parts):

```

X(PAN) | Y(TILT) | MIRROR/HEAD
H[---]L -- | H -- L -- | OUTPUT ok->

```

- Setting for Slope Speed, done bearing in mind that both the dimmer and the Flasher DMX 1.5 flash rate have linear regulation:

```

DIM01 RAT01 DIM02 RAT02 DIM03 RAT03 <->
[SOFT] SOFT SOFT SOFT SOFT SOFT P1

```

```

DIM04 RAT04 DIM05 RAT05 DIM06 RAT06 <->
[SOFT] SOFT SOFT SOFT SOFT SOFT P2

```

```

DIM07 RAT07 DIM08 RAT08 DIM09 RAT09 <->
[SOFT] SOFT SOFT SOFT SOFT SOFT P3

```

```

DIM10 RAT10 DIM11 RAT11 DIM12 RAT12 <->
[SOFT] SOFT SOFT SOFT SOFT SOFT P4

```

```

DIM13 RAT13 DIM14 RAT14 DIM15 RAT15 <->
[SOFT] SOFT SOFT SOFT SOFT SOFT P5

```

- Setting for the new fixture's name:

```

ENTER/MODIFY THE NAME OF THE UNIT
-SuperFlasher-

```

- Setting for remote reset and lamp ignition (not available on the Flasher):

```

RESET OFF ON | LAMP OFF ON
[---] --- --- | --- --- --- ok->

```

- Choosing the setting modes, i.e. the way in which the start address has to be calculated. On a Flasher DMX 1.5, the setting is done using rotary switches that indicate the address in decimal numbers, so this setting is useless:

```
ENTER THE DIP-SWITCH CONFIGURATION
n.dip=[--] primo canale= -          ok->
```

- Setting Beam Search values, of no use with this unit:

```
DIM01 RAT01 DIM02 RAT02 DIM03 RAT03 <->
[ --]  --   --   --   --   --   P1
```

```
DIM04 RAT04 DIM05 RAT05 DIM06 RAT06 <->
[ --]  --   --   --   --   --   P2
```

```
DIM07 RAT07 DIM08 RAT08 DIM09 RAT09 <->
[ --]  --   --   --   --   --   P3
```

```
DIM10 RAT10 DIM11 RAT11 DIM12 RAT12 <->
[ --]  --   --   --   --   --   P4
```

```
DIM13 RAT13 DIM14 RAT14 DIM15 RAT15 <->
[ --]  --   --   --   --   --   P5
```

- Setting the control of the parameters for the channels (Linear or Tabular), in which there is only the Linear value, as the two channels have continuous regulation:

```
DIM01 RAT01 DIM02 RAT02 DIM03 RAT03 <->
[LIN] LIN  LIN  LIN  LIN  LIN  P1
```

```
DIM04 RAT04 DIM05 RAT05 DIM06 RAT06 <->
[LIN] LIN  LIN  LIN  LIN  LIN  P2
```

```
DIM07 RAT07 DIM08 RAT08 DIM09 RAT09 <->
[LIN] LIN  LIN  LIN  LIN  LIN  P3
```

```
DIM10 RAT10 DIM11 RAT11 DIM12 RAT12 <->
[LIN] LIN  LIN  LIN  LIN  LIN  P4
```

```
DIM13 RAT13 DIM14 RAT14 DIM15 RAT15 <->
[LIN] LIN  LIN  LIN  LIN  LIN  P5
```

This setting finishes the procedure for creating multiple units.

Working in this way means that operators can also create multiple colourchangers, for example by setting 5 SGM Colorbasic 250 fixtures (which require 5 channels each) in a single unit. In this case, addressing must be in blocks of five.

11.2 - Multiple scanner units

Scanners (or moving head fixtures) have 4 channels reserved for control of the moving parts (see parag. 8.5.1.6).

When creating a multiple unit, it's impossible to assign more than one channel to movement con-

trols (joystick and cursor), due to the complexity of this type of control.

It's therefore inadvisable to create multiple scanner units, unless they're extremely simple units (requiring few control channels), in which case it's possible (setting 8-bit mirror movement on the fixture) to "make do" by moving the mirror using two faders for Pan and Tilt.

In this case, it's more practical to use these units as "extra units" and therefore control them using programs.

To create a multiple scanner set-up, the same logic is used as in parag. 11.2, taking into consideration this possible effect string:

```
Enter the string for effects      more<->
PAN*Q1*TILT DIMM  SHUT  GOBO  COLOR  P1
```

Here again, as Pan and Tilt aren't assigned to the joystick, but to two faders, nothing will be entered in the page regarding Mirror/Head settings.

11.3 - Using colourchangers in pseudo-random mode

To achieve particular effects, it's possible to "cheat" on the real identity of a fixture.

Taking an SGM Colorlab 250 as an example, it can be "transformed" into a scanner with 8-bit movement: all that's necessary is to set the channels that would be used for Pan and Tilt to the channels relative to Colour and Shutter.

So when a program's being prepared, the Movement Effects application (parag. 7.3), which continually sends the Pan and Tilt channels the co-ordinates of the points forming the pattern, will generate an apparently random number of parameters, running the colours in an unpredictable manner.

It's therefore possible to create a program in which several colours are run in a single scene.

12 - Quick reference

This section sums up the function buttons on the Studio 24 Scan Control and their applications.



manual presets cross time

This control sets the time for the automatic crossfade between preset A and preset B (GO function - parag. 7).



The LINK function allows to unlatch one or more dimmer channels from presets A and B, linking their output level only to the GRAND MASTER. It also allows to transfer the new value of one or more channels to the Memory Registers to carry out easy variations in the stored scenes.



The SOLO function enables flashing in subtractive mode. When enabled, if the channels' Flash buttons are pressed, all the dimmer channels are switched off except those of the pressed buttons.

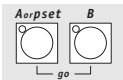

These two buttons switch Preset A and B on or off. When used in "Double Preset" mode (parag. 3), allow the GO function to be enabled (parag. 7).

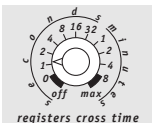

registers cross time

This control sets the time for the automatic crossfade from one Memory Register to another. Only has effect on the registers operating in AND and OR mode.



This function is used to store the scenes created on Presets A and B in a Memory Register.



The function allows to run Event previously recorded Event.

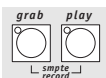

Pressing GRAB and PLAY simultaneously enables the Event Recording function, which can also be run in sync with the SMPTE signal, thanks to the connector that the console is fitted with.



appendice

page



This function is used to select a page of the Memory Registers. Studio 24 Scan Control has 24 pages.

mode



● and
● or
○ flash

This function allows to assign the Memory Registers' operating mode. Operating modes are And, Or, Flash and Flash or Fader.

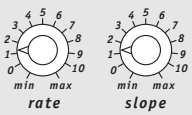

These two controls are used to regulate Light Chases' running speed. Rate shows the length of the step, Slope the step's slope time.

music



This button is on both the Light Chase Control and DMX Unit Control sections, enables music sync and replaces the RATE parameter which normally regulates the steps of a chase and the scenes on the Scan Control.

step



This function allows to select the steps of a Light Chase to run and also (during creation and modification of a chase) to select the step to be modified.

edit



This function (only enabled when operating in DIRECT mode) is used to create or modify a chase.

reg



This function, located in both the Light Chase Control and DMX Unit Control sections, allows to pass to the control mode of the parameters in the Memory Registers. In the Light Chase Control section, allows to assign a chase to a Memory Register and also to modify running parameters or enable the required steps of the Chases created. In the DMX Unit Control section, allows to change the parameters of assignment of a scanner program in a Memory Register.

chase



This function allows to select the Light Chase to execute, assign to Memory Registers and Edit.

direct



This function, located in both the Light Chase Control and DMX Unit Control sections, allows to output a light chase or a scanner program (according to the section in question) independently of the Memory Registers.

Light chases and scanner programs can only be created in DIRECT mode.

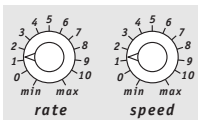

These two controls are used to adjust scanner programs' running speeds.

RATE indicates the program running time, SPEED the mirror (or moving head) movement time and the passage from one effect to another with effects controlled in SOFT mode in the unit library.

bkward



When this function is enabled, scanner programs run from scene 12 to scene 1 (they normally run from 1 to 12).

pause



This function is used to put a program on pause at the required point. It doesn't freeze action, so if a Rotogobo function is enabled on one unit, it continues operating. If a scene crossfade is running, it will be finished.

store



This function is used to store the scenes during program creation procedure and also to add the program running to a Memory Register.

util



This button is used to enable the console's Utilities, in which it's possible to send Reset and lamp on/off commands (to fixtures on which these functions are enabled) and to define and control the scanning area of scanners or moving head fixtures.

setup



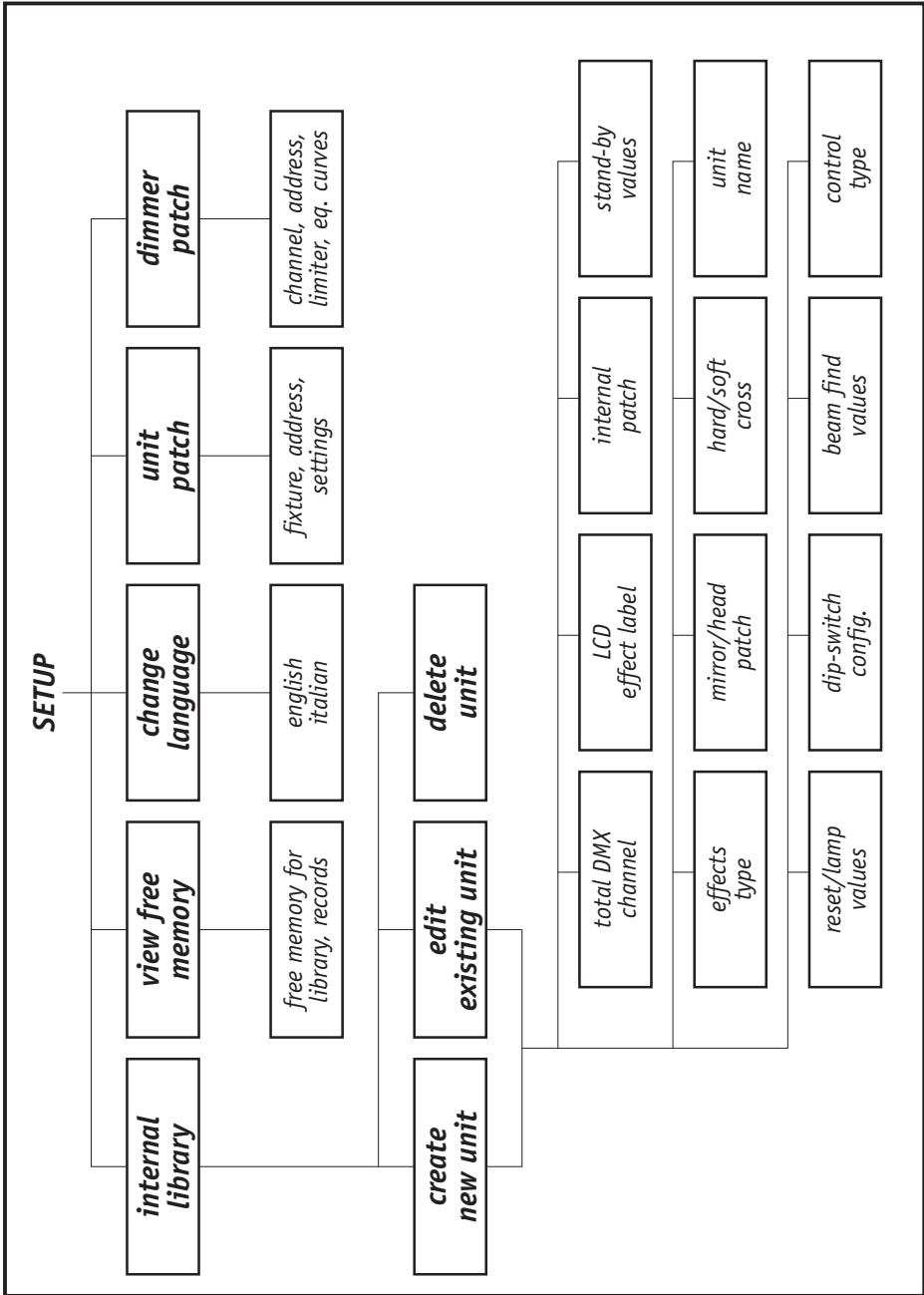

This button enables the setup functions of the Scan Control section, in which the units in the library are created, addressed and modified.

12 - Tree structure diagram of Setup functions



13 - Practical users guide

The following pages contain the series of commands to use to obtain a particular condition. For convenience, the following three symbols indicate the status of the buttons' LEDs:

off (), on () or flashing ().

13.1 - Turning on light channels

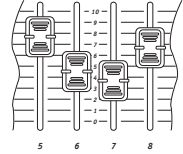

1 - set the required values using the faders of Preset A or B (or both)

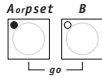

2 - Turn on preset A or B or both



3 - Set a level on preset A or B or both

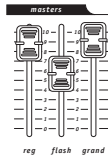

4 - Set a level on the Grand Master

13.2 - Crossfading manual presets (GO)

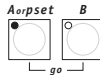

1 - Turn on preset A and turn off preset B



2 - Set a level on preset A or B or both

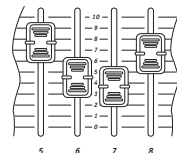

3 - Set preset A and preset B faders at the required levels

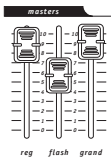

4 - Set a level on the Grand Master



5 - Set crossfade time *manual presets cross time*

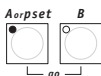

6 - Press buttons A and B simultaneously

13.3 - Storing a Memory Register

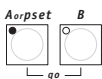

1 - Turn on preset A or B or both

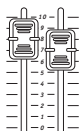

2 - Set a level on preset A or B or both

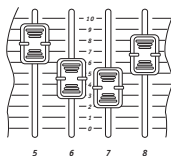

3 - Set preset A and/or preset B faders at the required levels

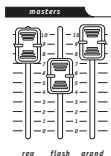

4 - Set the levels of the Grand Master and Reg Master



5 - Press the Grab button and hold it down.



6 - Press the button of the target Memory Register

13.4 - Generating flashes from the light channels

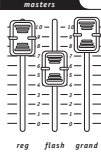

1 - Set the Master Flash level

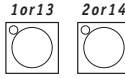

2 - Press the buttons of the channels below preset B

13.5 - Generating a subtractive flash

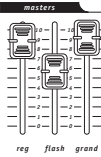

1 - Set the Master Flash level



2 - Enable the SOLO function

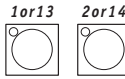

3 - Press the buttons of the channels below preset B

13.6 - Unlatching a light channel from presets A and B



1 - Press the LINK button and hold it down

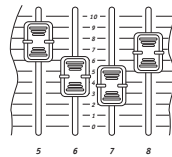



2 - Move the fader of the required channel on preset A





3 - Release the LINK button (the LED flashes)



13.7 - Unlatching a light channel from the Link

- 1 - Press the LINK button and hold it down  .
- 2 - Press the button of the channel to unlatch  .
- 3 - Release the LINK button (the LED goes off)  .

13.8 - Creating a chase

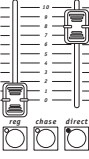
To create Chase 1, made up of 2 steps:

- 1 - Press the Direct button  .
- 2 - Select Chase 1 by pressing  +  .
- 3 - Set the Chase output level as required  .

- 4 - Press the Edit button  .
- 5 - Select step 1:  +  .

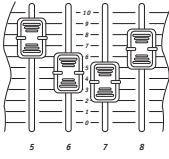
- 6 - On preset A, move the faders of the required channels  or press the









- individual channel buttons  .
- 7 - Repeat points 5 and 6 for step 2.

- 8 - Press the Edit button  .







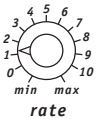
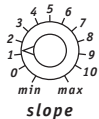





13.9 - Running a chase

To run the Chase 1 created in 13.8 (made up of two steps):

- 1 - Press the Direct button  .
- 2 - Select Chase 1 by pressing  +  .
- 3 - Set the Chase output level as required    .
- 4 - Select the steps to run:  +  +  .
- 5 - Set running time   .



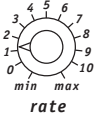
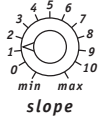

13.10 - Assigning a chase to a Memory Register

To assign the Chase 1 created in 13.8 to Register 1:

- 1 - Press and hold down the Reg button, followed by the required Register button  +  .
- 2 - Select Chase 1 by pressing  +  .
- 3 - Set the Chase output level as required    .
- 4 - Select the steps to run:  +  +  .
- 5 - Set running time   .



13.11 - Deleting a chase from a Memory Register

To delete Chase 1 from Register 1:

- 1 - Press and hold down the Reg button, followed by the required Register button  + .
- 2 - Delete the Chase by pressing  + .

13.12 - Switching off a chase in Direct mode

To switch off Chase 1:

- 1 - Press the Direct button .
- 2 - Switch off Chase 1 by pressing  + .

13.13 - Re-addressing a dimmer channel

To address channel 12 in the manual preset section to DMX channel number 512 in On/Off mode:

- 1 - Press button .

- 2 - Use the Up/Down arrows to scroll to

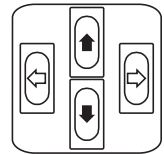

```

CONFIGURATION & SET UP
SELECT --> [DIMMER PATCH      ]  ok->
    
```

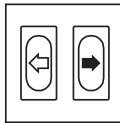

- 3 - Press the right-hand Scroll button
- 4 - The following appears on the display:

```

DMX-CH  CHANNEL  LIM%  EQUAL  ok->
[001] <----  --  ---  -  <DEL>
    
```

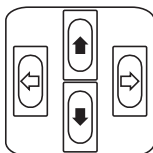

5 - Press the cursor Up/Down buttons to set the DMX channel the console's physical channel has to be addressed to until the required channel appears:

```
DMX-CH  CHANNEL  LIM%  EQUAL  ok->
[512]  <-----  -    -    -    <DEL>
```

6 - Use the Left/Right cursor to go under the "DMX-CH" field and set the logic channel of the mixer which has to control channel 512 (if the values weren't preset, selecting the logic channel automatically creates the LIM% and EQUAL "fields"):

```
DMX-CH  CHANNEL  LIM%  EQUAL  ok->
512  <-----  [12]  -    -    <DEL>
```

7 - Use the Left/Right cursor to go under the "Equal" field and set the EQ curve to be applied to channel 512:

```
DMX-CH  CHANNEL  LIM%  EQUAL  ok->
512  <-----  12  -    [8]  <DEL>
```



8 - Press the button to store the configuration and exit Setup.

13.14 - Addressing unit 1 to the Scan Control

With a Victory II 250 addressed starting from channel 50:



1 - Press button

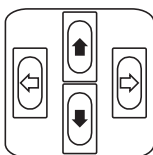

2 - Use the Up/Down arrows to scroll until

```
CONFIGURATION & SET UP
SELECT --> [UNIT PATCH]  ok->
```

appears on the display

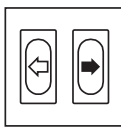

3 - Press the right-hand Scroll button



4 - Press the Unit 1 button

5 - The following menu is displayed:



```

UNIT   TYPE           FROM   --- 1--cod--10
[ 1]-----<DEL>TO --- 00000000

```

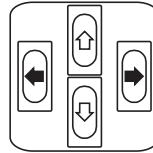

- 6 - Press the right-hand cursor button to set the field to be modified
- 7 - Use the Up/Down buttons to select the Victory II:

```

UNIT   TYPE           FROM   --- 1--cod--10
1 [VICTORY 2 ]<DEL> A --- 00000000

```

- 8 - Use the Left/Right buttons to select the FROM field (start address) and set the required value:

```

UNIT   TYPE           FROM [050]1--cod--10
1 VICTORY 2 <DEL> A - 57 "uu"uu

```

- 9 - Check the configuration of the dials on the display and set the fixture's in the same way.



- 10 - Press the  button to store the configuration and exit Setup.

13.15 - Using a unit in manual

To control unit 1 as set in parag. 13.14 (operating indifferently in DIRECT or REG mode):



- 1 - Press the Unit 1 button .
- 2 - Set the scanner controls as required using the faders, checking the value of the command sent on the display:

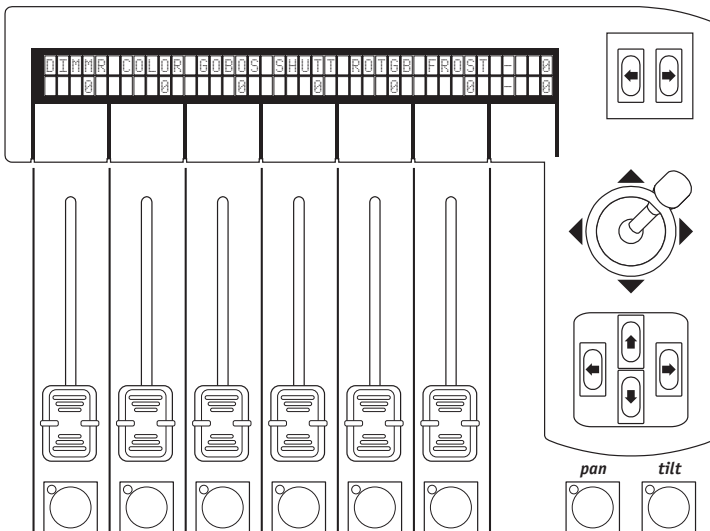



13.16 - Creating a Scan Control program

To create program 1, made up of 1 scene and using 1 unit:

1 - Press the Direct button .

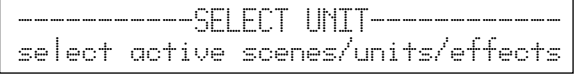
2 - Press and hold down the Prog button of the required program .

3 - The following menu appears: 

4 - Press the buttons of the scenes that have to make up the program: .

5 - Press the buttons of the units to be used in the program: .

6 - Press the buttons (below the faders) of the selected unit's effects to be used in the program.

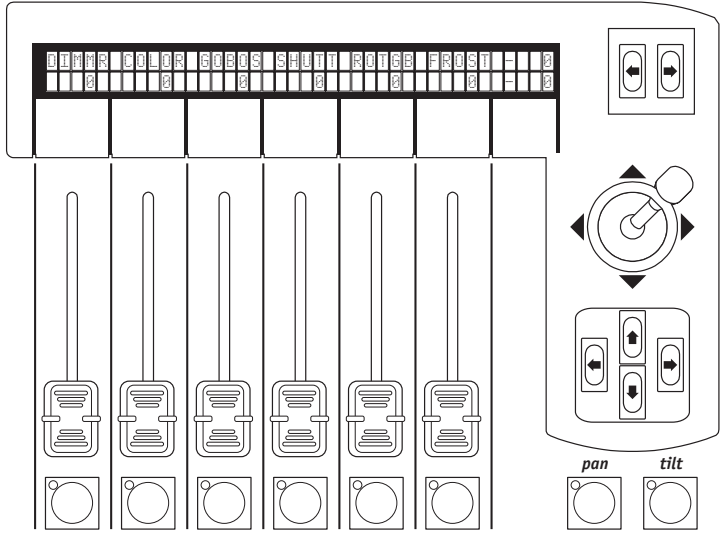

7 - Release the Prog button of the required program .

8 - Press the Prog button of the required program .

9 - Press the button of the scene to be created or modified: .



10 - Press the button of the unit to be controlled:

11 - Set the parameters required on Unit 1.

12 - Press and hold down the Store button, followed by the button of the scene to be stored:

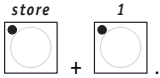

+



13 - Press Pause to start the program running again

13.17 - Adding a program to a Memory Register

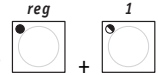

+



1 - Press and hold down the Reg button, then the button of the required Register

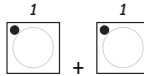

+



2 - Select Program 1 by pressing PROG

3 - Select Scenes, Units and Effects as described in 13.16.

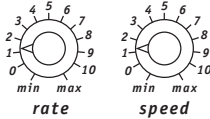

4 - Set running time

5 - Press and hold down the Store button followed by the Memory Register in which the program

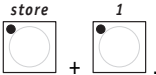

+



has to be stored:

13.18 - Deleting a program from a Memory Register



+

1 - Press and hold down the Reg button, followed by the button of the required Register



2 - Delete Program 1 by pressing PROG



(the LED goes off).

3 - Confirm the operation by pressing and holding down the Store button followed by the button

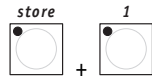

+



of the Memory Register the program has to be deleted from

cod. M001210



LIGHT TECHNOLOGY

Via Pio La Torre, 1 • 61010 TAVULLIA (PS) • ITALY •

Tel. +39 0721476477 • Fax +39 0721476170

www.sgm.it • info@sgm.it