

**ALLEN & HEATH**

**SQ**

Reference Guide

Firmware V1.0.1

1. Important information.....	5
2. Introduction.....	6
3. Updating firmware.....	7
4. Operational Overview.....	8
4.1 Physical control of the SQ.....	8
4.2 Channel types.....	9
4.3 On-screen parameters, menus and pop-ups.....	9
4.4 On-screen title bar.....	10
4.5 Home screen.....	11
4.6 Diagnostics.....	11
4.7 Basic workflow concepts.....	12
4.8 Screens Reference.....	13
5. Connections.....	14
5.1 Local inputs.....	14
5.2 Local outputs.....	14
5.3 SLink.....	15
5.4 USB.....	15
5.5 Network.....	15
5.6 I/O Port.....	15
5.7 Footswitch.....	15
6. I/O Patching.....	16
6.1 Local.....	17
6.2 SLink.....	17
6.3 ME systems.....	17
6.4 USB.....	18
6.5 I/O Port.....	18
7. Processing.....	19
7.1 Preamp.....	20
7.2 Gate (input channels).....	22
7.3 Insert.....	23
7.4 GEQ (mix channels).....	25
7.5 HPF and PEQ.....	26

7.6 Compressor .....	27
8. Routing.....	29
8.1 Direct out.....	30
8.2 Mix send and balance settings.....	31
8.3 DCA/Mute Groups.....	32
8.4 Send levels and mix assignments.....	33
8.4 Assigning a mix to a matrix .....	33
9. Metering .....	34
9.1 PAFL LED Meter.....	34
9.2 Input/FX/Output Meters.....	34
9.3 RTA .....	35
9.4 Other Metering .....	35
9.5 Chromatic Channel Metering .....	36
10. FX Engines .....	37
10.1 Using FX buses and returns.....	37
10.2 Loading units and pre-sets.....	38
10.3 Adjusting parameters .....	38
10.4 Sending to FX from other sources .....	39
10.5 FX Levels and PEQ .....	40
11. Saving and Recalling Shows/Scenes .....	41
11.1 Scene manager.....	42
11.2 Global Filter.....	43
11.3 Safes .....	43
11.4 Show manager (USB) .....	44
12. Setup .....	45
12.1 Strip assign .....	45
12.2 Input/Mix stereo assign .....	46
12.3 Mix bus configuration.....	47
12.4 SoftKeys/SoftRotaries .....	48
12.5 Footswitch.....	50
12.6 Surface Preferences.....	51
12.7 PAFL.....	52

12.8 Audio Sync and AES sample rate .....	53
12.9 Talkback settings .....	54
12.10 Signal Generator .....	55
12.11 Network Setup.....	56
13. SQ-Drive and USB-B.....	57
13.1 SQ-Drive stereo recording and playback.....	58
13.2 SQ-Drive multitrack recording and playback .....	60
13.3 Connecting to a computer .....	62
14. MIDI and DAW Control.....	63
14.1 MIDI channel and MMC.....	63
14.2 MIDI fader strips .....	64
14.3 DAW Control .....	64
15. Mix/System Reset.....	65
15.1 Reset Mix Settings.....	65
15.2 System reset .....	66
15.3 Fader Calibration.....	66
16. Block Diagrams.....	67
17. Specifications .....	69
18. Warranty Information.....	74

# 1. Important information

## Safety

Before powering on the SQ, read the safety instructions sheet (AP9240/CL1-1) supplied with the unit. For your own safety and that of the operator, technical crew and performers, follow all instructions and heed all warnings included in these documents and printed directly on the equipment.

## Ventilation

Do not obstruct the sides of the SQ, or any of the air vents when in use. Adequate ventilation is required for the cooling fans especially.

## Support

For further support with SQ, please visit [support.allen-heath.com](http://support.allen-heath.com), or contact your local distributor.

## Registration

To be kept informed of updates, the latest firmware and new releases for the SQ range, register your SQ at [www.allen-heath.com/registerSQ](http://www.allen-heath.com/registerSQ)

### Firmware updates and apps

Visit [www.allen-heath.com](http://www.allen-heath.com) to obtain the latest version of firmware, release notes and reference guide.

Firmware releases contain important updates and performance enhancements, and are also required for access to the latest DEEP Processing units.

The firmware on the SQ and version of any app must have the same major release number. This is the first two digits of each release number.

i.e. 1.0.3 and 1.0.5 = compatible

1.0.3 and 1.1.3 = **not** compatible

## 2. Introduction

Welcome to the SQ Reference Guide.

Designed for applications where high-quality audio mixing and processing is required in a compact and reliable unit, and built on an Allen & Heath XCVI core, the SQ series of digital mixers feature 96kHz, variable bit-depth processing and ultra-low latencies.

Both SQ models can be used standalone, or expanded with a range of remote audio units and option cards. They can also be customised and upgraded with additional processing options.

Having the same processing core means both models have the same mixing capabilities, and so this guide is generalised. Where necessary, it will be noted which model is being discussed. The differences are as follows:

Model	Faders	Preamps	XLR Outputs	SoftKeys	SoftRotaries
<b>SQ-5</b>	16+master	16+talkback	12	8	0
<b>SQ-6</b>	24+master	24+talkback	14	16	4

### 3. Updating firmware

- 1) Insert a new or formatted USB drive into the SQ-Drive port on the front of the SQ.
- 2) Press the **'Utility'** screen key, and select **'USB Utility'**.
- 3) In the **'Status/Format'** tab, both windows should say **'Ready'**. If they do not, you will need to ensure you are in the correct USB mode.  
[To switch between USB B and SQ-Drive modes, press the **'I/O'** screen key, then touch the **'USB'** tab above the routing matrix. The USB Source button is displayed at the top left of the grid and touching this will switch between the modes. To update the firmware, the button should read **'SQ-Drive'**.]
- 4) Press the **'Format'** button and follow the on-screen instructions to format the drive, this will clear all data and set up the SQ-Drive folder structure.
- 5) Once formatted remove the drive and connect to a Windows or Mac computer.
- 6) Download the latest version of firmware from [www.allen-heath.com](http://www.allen-heath.com), ensuring you choose the correct version for the SQ model you wish to update.
- 7) Unzip/expand the downloaded ZIP file and copy the firmware file (which has a .bin suffix) to the root of the USB drive, do not place it in any of the folders. Ensure there is only one firmware file on the USB drive at any one time.
- 8) Safely eject the drive and re-insert into the SQ.
- 9) Now press the **'Utility'** screen key, select **'USB Utility'** and touch the **'Firmware Update'** tab.
- 10) This screen will display the firmware version found on the USB drive. Touch the **'Update'** button to begin the update process.
- 11) Follow the on-screen instructions and touch the **'Reset'** button when prompted to reboot the SQ and complete the firmware update.
- 12) Check the displayed firmware version on the home screen, or press the **'Utility'** screen key and select **'General'**. The firmware version is displayed in the **'Diagnostics'** tab.

## 4. Operational Overview

### 4.1 Physical control of the SQ

**Keys** – All keys are labelled, and most illuminate to show when they are active. All perform specific functions, aside from the ‘SoftKeys’ which are user assignable.

**Faders** – There are 6 layers of assignable fader strips. For all inputs and FX returns the fader controls the send level of this channel to the selected mix. FX Send, Mix (Aux/Group) and Matrix faders control master levels. DCA faders control the level of the DCA groups, and MIDI faders send MIDI level messages. All fader strips are also used by the GEQ ‘Fader Flip’ function.

**Rotary Encoders (Rotaries)** – These illuminate when active and are used to adjust various parameters. Most are dedicated to parameters for the currently selected channel or mix, though one is for use with the touchscreen. The SQ-6 features 4 additional ‘SoftRotaries’ which are user assignable.

**Touchscreen** – The touchscreen allows simple user interaction through on-screen buttons and menus. Parameters can also be selected on-screen and adjusted using the touchscreen rotary. When a parameter is selected, it will turn yellow on the screen, and the touchscreen rotary will illuminate to indicate it can be used.

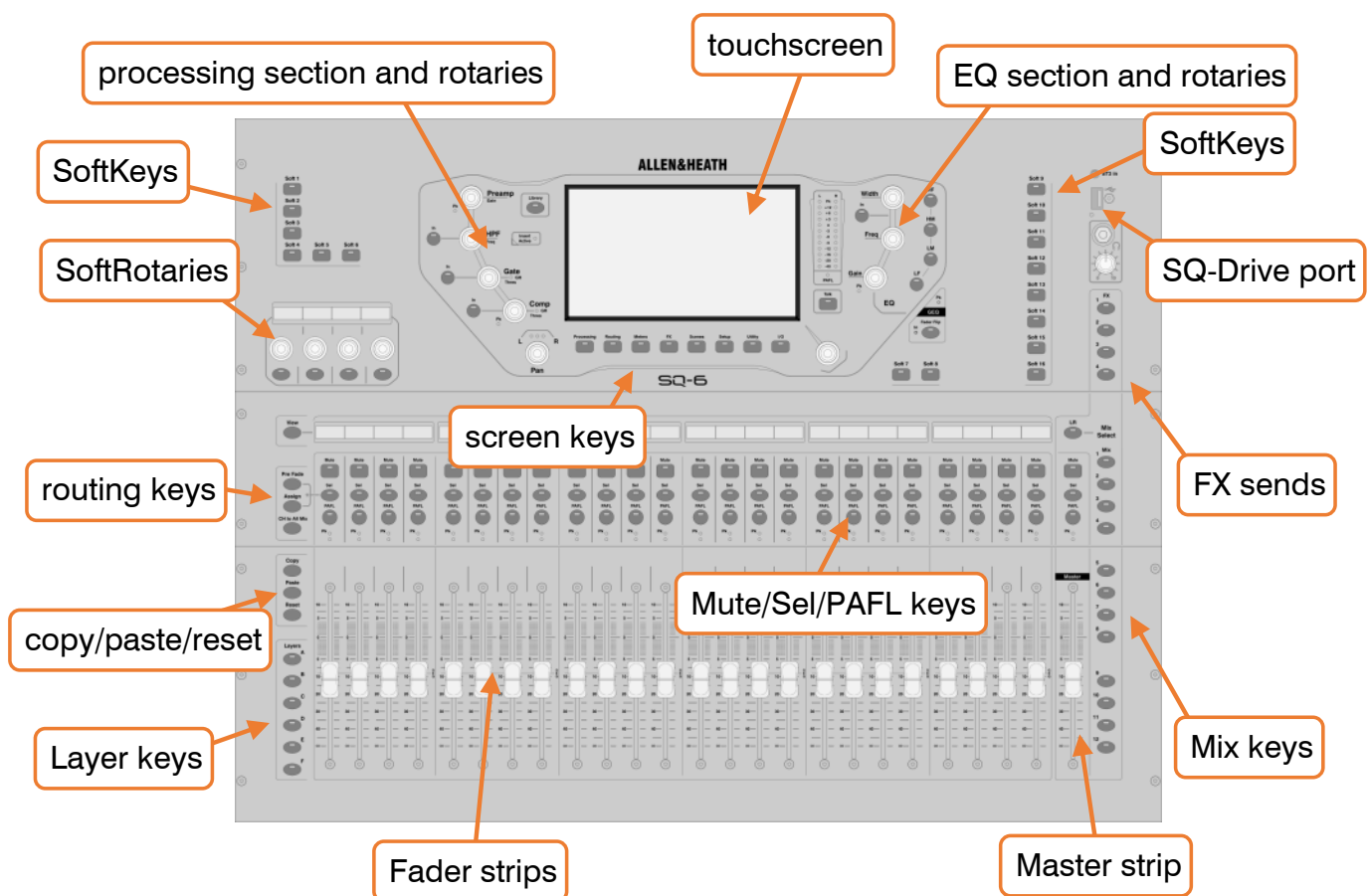



## 4.2 Channel types

Input channels – 48 input channels with processing. These can be sourced from local, remote or digital connections, and mixed to any output.

Main LR – This is the main mix. All post-fader modes and options follow this mix.

Mix channels – 12 stereo mix channels with processing that can be used as either auxiliaries or groups.

FX sends – 4 FX send buses are included for use with the FX engines.

FX Returns – 8 stereo dedicated return channels for the FX engines.

Matrix – 3 stereo matrix buses that can be made up of a combination of other buses.

DCA – 8 ‘Digitally Controlled Amplifier’ channels for adjusting the level of multiple channels with one fader.

MIDI – 32 channels which send MIDI control data using MIDI over USB and MIDI over TCP/IP.

## 4.3 On-screen parameters, menus and pop-ups

Adjustable parameters and selections – These are displayed as white text on a black background. Values are displayed in text as well as in a bar.

Libraries – Where available, pressing the ‘**Library**’ key displays a library window, allowing you to store or recall settings for the selected channel/processing or FX unit. Pre-sets are stored in the Factory library, and a User library is provided to store your own settings. Libraries are also used to load FX units, through the loading of a pre-set.

Menu lists – With short lists, touch an option to select it. Longer lists can be navigated by highlighting an option, then using the touchscreen rotary to scroll through all available options. An ‘X’ is displayed to the top right of most pop-up menus.

**Keyboard** – An on-screen keyboard is displayed when entering names or numbers. Touch and hold ‘^’ (shift) to enable caps lock. Touch ‘**Apply**’ or ‘**OK**’ to set the name or number. Touch the ‘**X**’ at the top right of the keyboard to close it.



**Confirmation** – Certain actions require confirmation. Where there is an option to apply or cancel changes, buttons will show as active on-screen. In some cases, a pop-up with more information and choices will be displayed.

#### 4.4 On-screen title bar

The title bar is always visible at the top of the screen, from left to right it displays the following information:

- The title of the currently selected window.
- The currently loaded scene.
- The next scene to be recalled.
- An SLink port symbol (when an SLink connection is available).
- A red cross when an error is detected (tap on this to see a pop-up window with the detected error).
- A USB symbol when a USB device is connected to the SQ-Drive port. This is replaced with transport symbols when using SQ-Drive for audio recording or playback.

## 4.5 Home screen

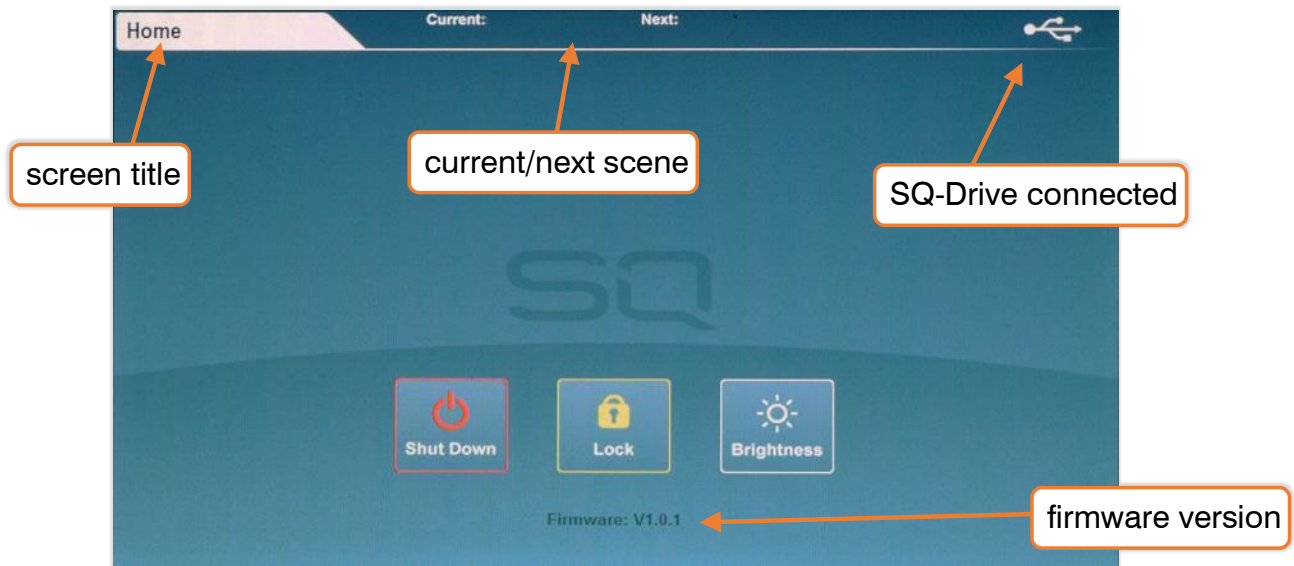

This is the first screen shown when powering on the SQ. It is also shown when no channels are selected, and no other screens are active. The firmware version is displayed below three buttons.

**'Shut Down'** – Touch to shut down the SQ.

**'Lock'** – Touch to lock the SQ surface and avoid accidental adjustments.

**'Brightness'** – Touch to go directly to the SQ brightness settings.

## 4.6 Diagnostics

To get to the diagnostics, press the **'Utilities'** screen key and touch the **'General'** tab. This displays important information about the SQ, including the unique DNA code, which is required for registration.

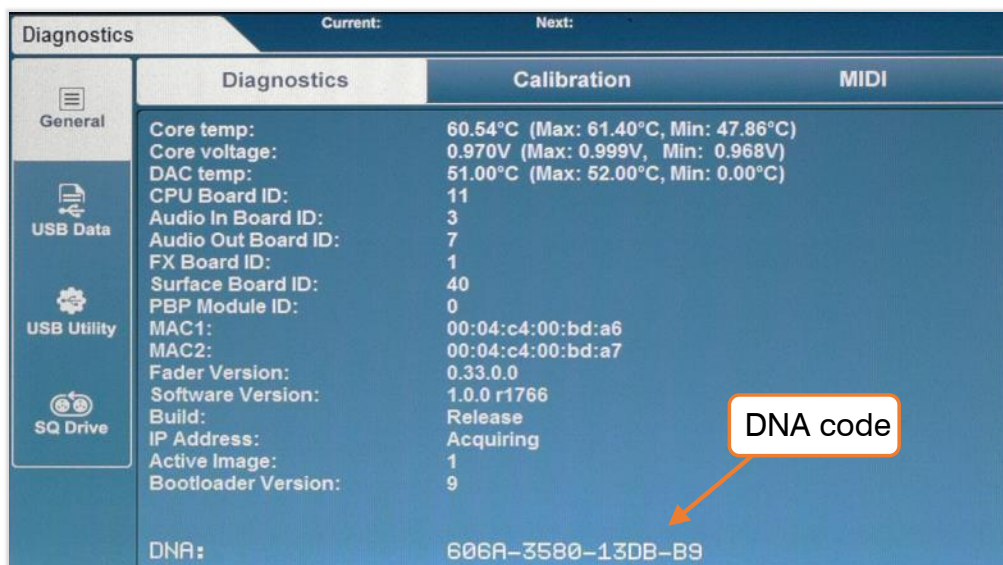

- Press '**LR**', '**Mix**' or '**FX**' key to present send levels for the selected Mix on the Fader Strips.  
Use the layer keys to move through the 6 layers of faders and adjust individual levels.  
The Master strip controls the master send level of the selected Mix/FX.
- Select a strip by pressing a '**Sel**' key. The physical controls can now be used to adjust parameters for the selected strip.
- Go to the '**Processing**' screen to see an overview of the processing for the selected strip.  
Touch on any part of the processing to see a detailed view, then touch a parameter on-screen and use the touchscreen rotary to adjust.
- Mute keys are illuminated when a strip is muted.  
By default, '**PAFL**' (**Pre/After Fade Listen**) keys allow you to route one channel at a time to the PAFL bus/Headphone output.
- Mix sends set to 'Post-Fade' follow the LR send levels. To toggle channels between 'Pre-Fade' and 'Post-Fade' for the selected Mix, hold the '**Pre Fade**' key and use '**Sel**' keys.  
To assign or un-assign a strip from the currently selected mix, hold the '**Assign**' key and use '**Sel**' keys.
- Pressing and holding the '**CH to All Mix**' key will display the send levels for the currently selected strip across the main fader strips.
- Press the '**FX**' screen key to view and adjust the FX engines.  
Use the '**Library**' key to recall FX types and pre-sets - change parameters by selecting them on-screen and using the touchscreen rotary.  
FX busses 1 to 4 send to FX engines 1 to 4 by default.  
FX Return channels can be routed to Mixes in the same way as stereo input channels.
- Hold the '**Copy**' key and press an '**In**' key, a '**Sel**' key or a '**Mix**' key to copy parameters or sends.  
Hold the '**Paste**' key and press a '**Sel**' key or Mix key to paste the processing or send assignments to another channel.  
Hold the '**Reset**' key and press an '**In**' key, a '**Sel**' key or a '**Mix**' key to reset parameters.

 Information on the initial state of the SQ can be found in the [Mix/System Reset](#) section of this guide.

## 4.8 Screens Reference

Screen Key	Option 1/Left Tabs	Option 2/Top Tabs
Processing	Name	Bank/Processing View
	Preamp (input), Ext In (mix)	
	Gate (input), Insert (mix)	
	Insert (input), GEQ (mix)	
Routing	Name	Bank/Assign and Level View
	Direct Out/Group/Aux Snd/FX Snd	
	DCA/Mute Assign	
	Mix Sends	
	Matrix Sends	
Meters	Input Meters	N/A
	FX Meters	
	Output Meters	
	RTA	
	Channel Meters	
FX	FX Engines 1-8	Front/Back Panel
Scenes	Scene Manager	N/A
	Global Filter	N/A
	Safes	Inputs
		FX
		Mix
Setup	Audio	PAFL
		Talkback
		SigGen
		Audio Sync Opts
	Surface	Strip Assign
		Soft Controls
		Footswitch
		Surface Prefs
	Mixer Config	Input Stereo
		Mix Stereo
		Bus Config
Network Setup	N/A	
Utility	General	Diagnostics
		Calibration
		MIDI
	USB Data	N/A
	USB Utility	Status/Format
		Firmware Update
	SQ-Drive	Stereo
Multitrack		
I/O	Inputs	Onput sources/destinations
	Outputs	Output sources/destinations

## 5. Connections

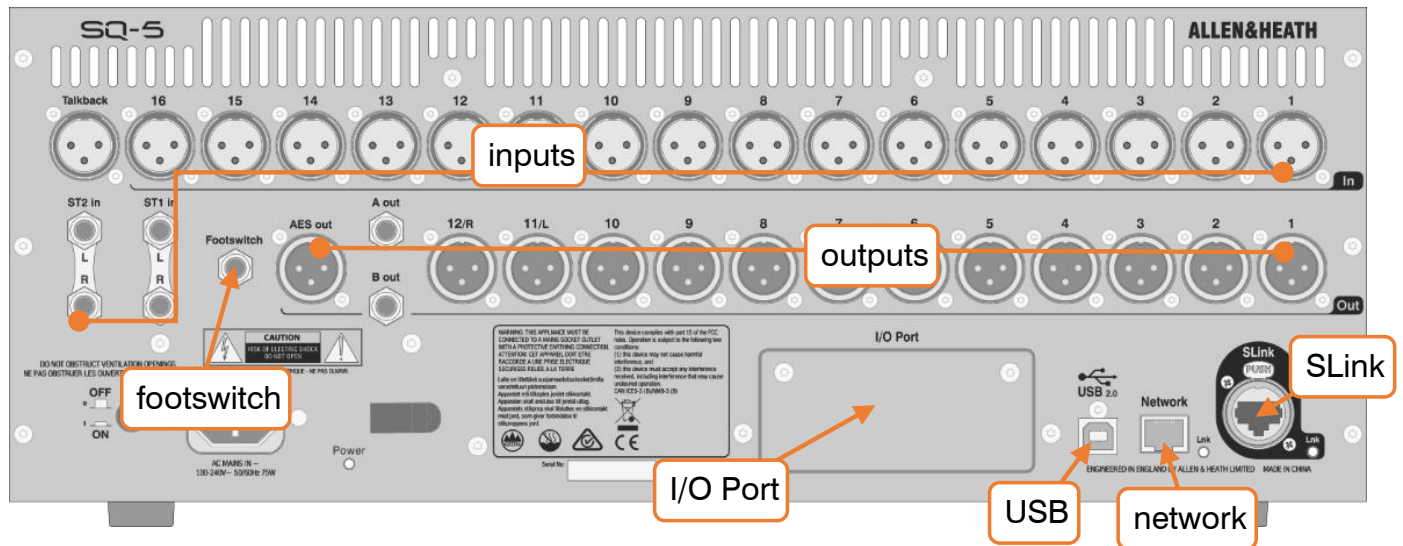

### 5.1 Local inputs

**Mono mic/line (XLR female)** – These are numbered and accept balanced mic or line level signal. Gain, Pad and 48v Phantom Power are controlled digitally.

**Talkback (XLR female)** – Identical to mono mic/line inputs. Intended for communication from the desk position, but can also be used as an additional input.

**ST1, ST2 (1/4" TRS jack)** – Labelled as stereo pairs, these can also be used as mono line level balanced inputs.

**ST3 (TRS Mini jack)** – Located on the surface of the SQ, this can be used with a line level source, such as a portable media player, laptop, tablet or smartphone, using a standard stereo mini jack cable.

### 5.2 Local outputs

**Mono line (XLR male)** – Line level outputs for sending mixes or direct outputs. These are numbered, and fully assignable. With default settings, the LR mix is sent to 11&12, as labelled.

**A/B mono line (1/4" TRS jack)** – Two assignable line level outputs, presented on balanced jack sockets for convenience.

**AES digital (XLR male)** – Stereo digital output clocked to SQ. For connection to equipment with a digital input.

**Headphone (1/4" TRS jack)** – Located on the surface of the SQ, with dedicated level control. Fed from the PAFL bus.

### 5.3 SLink

Digital multichannel (Neutrik etherCON) – For expanding the SQ using Allen & Heath Remote Audio Units. Mode switchable between dSnake, DX and gigaACE protocols.

- ❗ SLink does not support multiple protocols on a single connection.
- ❗ Firmware V1.0.1 does not support the connection of secondary (daisy chained) units.
- ❗ Check [www.allen-heath.com](http://www.allen-heath.com) for the full list of supported configurations.

### 5.4 USB

SQ-Drive – Located on the surface of the SQ. Can be used to connect USB ‘stick’ drives, or portable HDD’s or SSD’s. Used for storing and recalling data, firmware updates and stereo or multitrack audio recording and playback.

USB-B – For connection to a Windows or Mac computer, in order to use the built-in 32x32 audio and MIDI interface.

- ❗ See the [SQ-Drive and USB-B](#) section for more information.

### 5.5 Network

This is used to connect the SQ to a wireless router, access point or local area network, allowing the SQ to transmit and receive control data. For use with Allen & Heath SQ apps, and for MIDI over TCP/IP.

### 5.6 I/O Port

For the connection of SQ option cards, allowing expansion and connectivity using Allen & Heath or third-party protocols.

### 5.7 Footswitch

Connect a single or dual, momentary or latching footswitch, and use to control functions such as mutes or tap tempos.

- ❗ See the [Footswitch Setup](#) section for more information.

## 6. I/O Patching

There are two ways to patch channels, either in the Preamp section of the channel processing screen, or in the I/O screen. For patching multiple channels, it is easiest to use the I/O patching screen.

Press the 'I/O' screen key to display the patching matrix.

- Touch one of the tabs on the left:
  - 'Input Ch' = to input channels of the SQ.
  - 'Mix Ext In' = to the mix external inputs.
  - 'Direct Outs' = from the direct outs of input channels.
  - 'Mix Outs' = from all mix outputs (LR, Aux, Group, Matrix).
  - 'Rack FX' = from FX returns.
- When patching inputs, the source (local/digital/USB) is displayed at the top of the matrix and the destination (in the SQ) is displayed to the left. When patching outputs, the source (from the SQ) is displayed at the left of the matrix, and the destination (local/digital/USB) is displayed at the top.

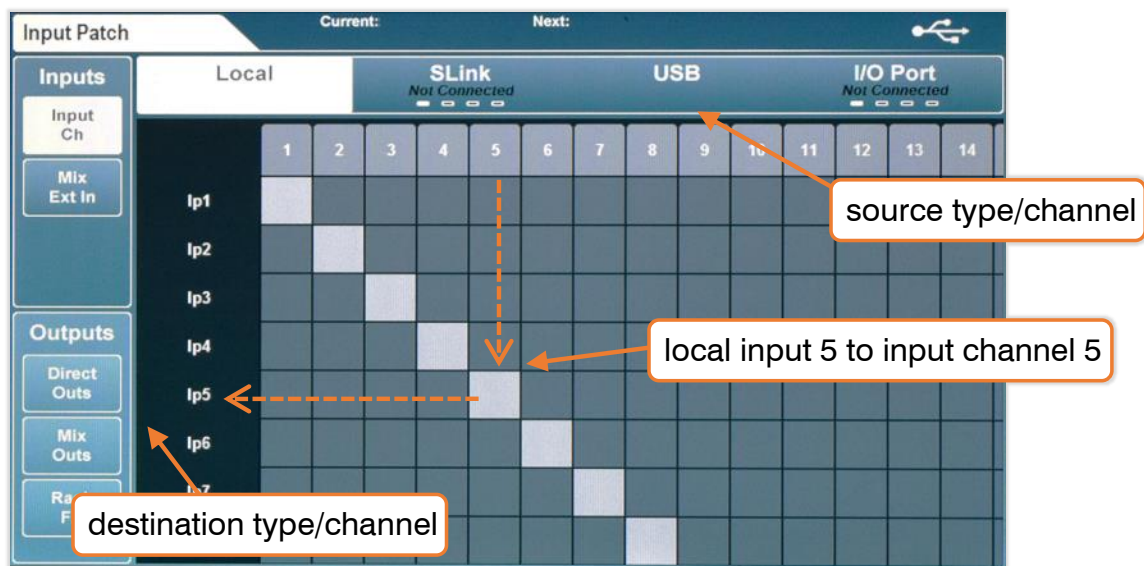

- Drag the grid on-screen to see more input and output channels.
  - Touch the 'SLink' or 'I/O Port' tab multiple times to display either channels 1-32, 33-64, 65-96 or 97-128. There are four marks on each tab to show which screen is currently displayed.
  - To create or delete a patch, touch a patching block.
  - Available patching blocks are grey, and are filled light grey when patched.
  - Currently unavailable patching blocks are dark grey and striped light grey when patched.
- ⓘ All patching to a currently disconnected device will become active once the device is connected.



## 6.1 Local

The local input and output options in the I/O screen match the analogue input and output socket labels on the SQ.

## 6.2 SLink

The SLink port is compatible with dSnake, DX and gigaACE. It switches between these modes, so multiple protocols over a single connection are not supported.

The current mode is shown on the tab unless nothing is connected, in which case **'Not Connected'** is displayed.

Check [www.allen-heath.com](http://www.allen-heath.com) for the full list of supported configurations, and details on socket numbering.

**i** Firmware V1.0.1 does not support the connection of secondary (daisy chained) units.

## 6.3 ME systems

ME-1 and ME-500 units are run on the dSnake protocol, so are only supported when connected directly, or when connected to the expander or monitor port of an AR2412 or AB168.

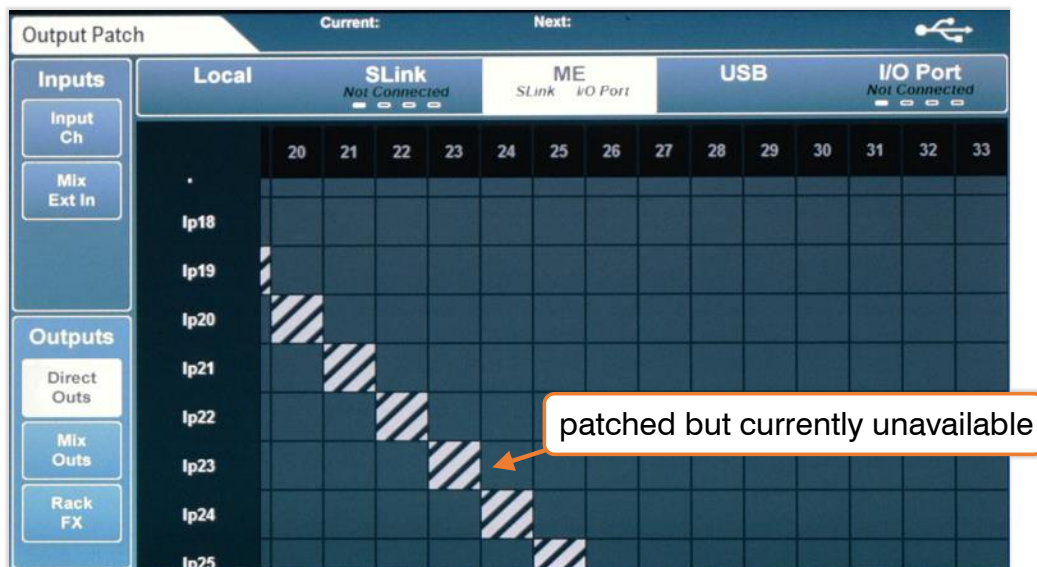

The ME patching is applied to either the SLink port, the I/O Port, or both.

**'SLink'** and **'I/O Port'** text on the **'ME'** tab show if the patching is currently active on either port.

**i** ME-1 units accept 40 total channels, ME-500 units accept 16 mono or stereo channels, stereo channels are set on SQ in the [Mixer Config](#) settings.

## 6.4 USB



USB patching is for SQ-Drive or USB-B streaming connections. SQ-Drive uses input and output USB channels 1 to 16 and USB-B uses input and output USB channels 1 to 32.

- ❗ SQ-Drive and USB-B modes are mutually exclusive. When the USB tab is active, the '**USB Source**' selection button will be displayed at the top left of the patching matrix, touch this to switch modes.

## 6.5 I/O Port

Used for patching to SQ option cards fitted in the I/O Port.

The current option card protocol is shown on the tab unless nothing is connected, in which case '**Not Connected**' is displayed.

- ❗ Option cards are not fully supported in firmware V1.0.1, so it is recommended that firmware is updated before fitting. Visit [www.allen-heath.com](http://www.allen-heath.com) to download the most up-to-date firmware.

## 7. Processing

Press any **'Sel'** key to select a channel. The physical controls and keys around the touchscreen will illuminate to show they are active, and can be used to adjust parameters for the selected channel.

Press the **'Processing'** screen key to display the processing 'bank view'.

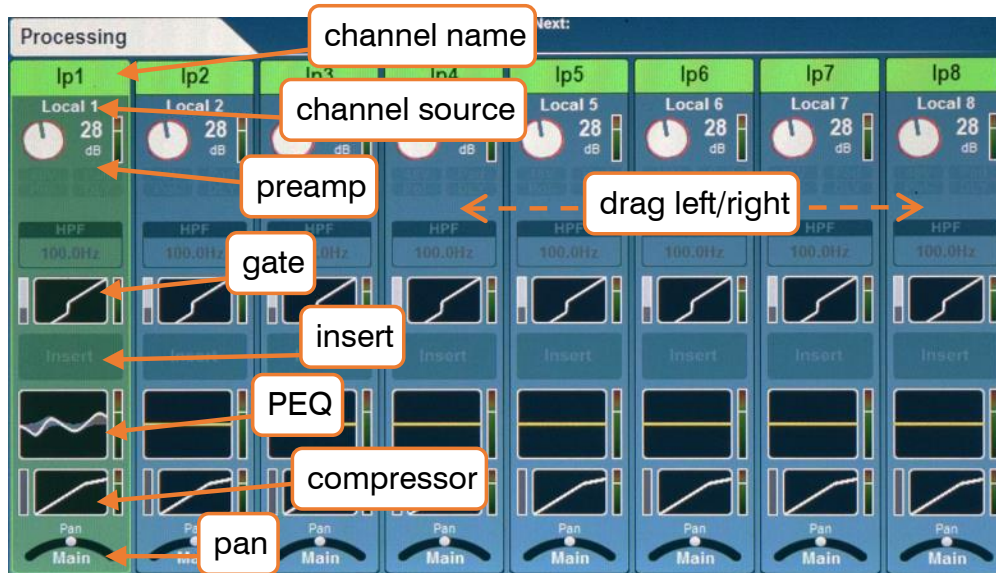

This gives the processing overview for 8 channels at once, with the selected channel highlighted. The view will automatically change if a channel is selected which is out of view, though you can also touch and drag to see all channels for the current layer. The selected mix channel is displayed to the far right.

- Touch a channel name to rename.
  - Touch **'Apply'** to set the name (it will now be displayed on the channel LCD display). The keyboard will remain on screen when other **'Sel'** keys are pressed, to speed up the naming of multiple channels.
  - Touch any processing 'block' to view and adjust it in detail. The channel overview will continue to be shown at the left of the screen. Selecting another channel will allow you to adjust the same parameters on the newly selected channel.
  - Touch the active block or press the **'Processing'** key to return to the bank view.
  - The order of audio processing is displayed from top to bottom.
- ❗ HPF is displayed in bank view in the correct order of processing (post-preamp), though it is viewed and controlled on the PEQ processing page for convenience.
- ❗ DCA channels display a list of up to 28 'members'. If there are more members than this, then '...' will appear at the bottom of the list.

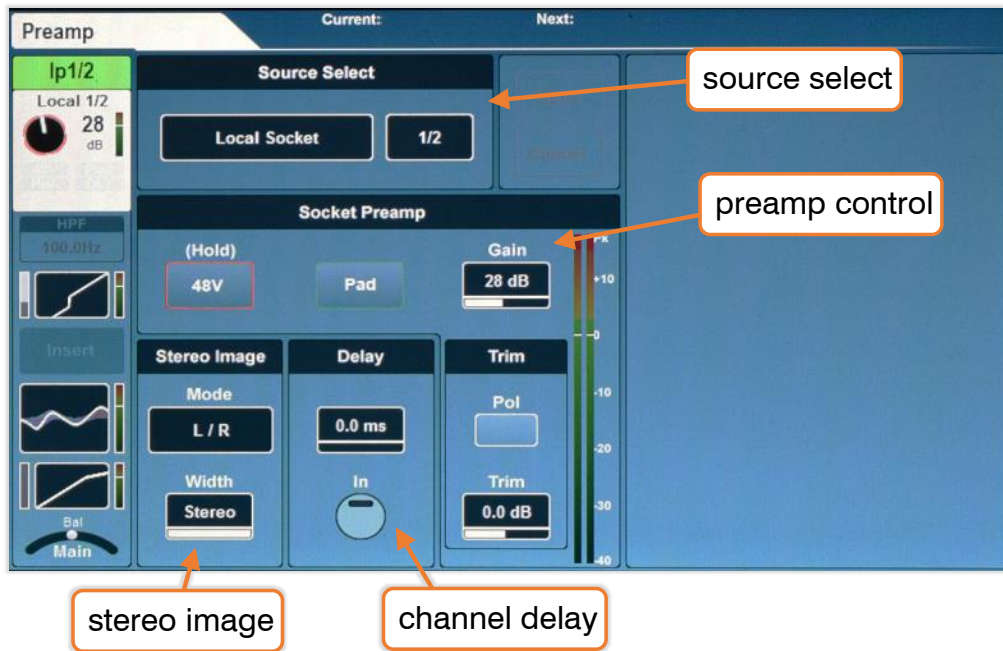

### Source Select –

- Touch the source type to select from a list of sources.

Unassigned = Channel has no source.

Local Socket = A socket on the rear of the SQ.

SLink Socket = A device connected to the SLink port (AR, AB and DX units. Other SQ's or dLive gigaACE option card).

USB Port = Either SQ-Drive or USB-B (depending on [mode](#)).

IO Port = SQ Option card.

Signal Generator = The inbuilt [signal generator](#).

- Touch the source channel and use the touchscreen rotary to scroll through channels.
- Source select on mix channels allows 'Mix Ext In' patching, to patch an unprocessed input directly to the mix bus.

## Socket Preamp –

- Touch and hold the '**48V**' button to switch phantom power on or off (channel will be automatically muted when switching this).
- Touch the '**Pad**' button to switch the -20dB pad in or out.
- Select '**Gain**' or '**Trim**' parameters to adjust using the touchscreen rotary. Gain can also be adjusted using the dedicated physical control.

Gain = 0dB to +60dB

Trim = -24dB to +24dB

- ⓘ Gain is for digitally controlled analogue inputs, such as local microphone inputs or those on a Remote Audio Unit. Trim is a purely digital adjustment, for digital or line signal.
- Touch the '**Pol**' button to invert the polarity of the channel.

Delay – In order of processing, the millisecond channel delay is actually located after the compressor. It is presented in the preamp screen as it is set at the same time as other parameters such as gain, which are not adjusted during mixing.

- Select the value to adjust using the touchscreen rotary.

Input channel delay = 0ms to 341.3ms

Mix channel delay = 0ms to 682.6ms

- Touch the '**In**' button to switch the delay in or out.

Stereo Image – This section is visible only when a stereo input channel is selected.

Touch the mode to select from the following options:

L/R = standard left/right.

R/L = switched left/right.

L-Pol/R = standard left/right with switched polarity on left.

R-Pol/L = switched left/right with switched polarity on right.

Mono = left and right fed to both channels.

L/L = left fed to both channels.

R/R = right fed to both channels.

M/S = for decoding a mid/side array (outputs M+S/M-S).

- ⓘ For normal M/S use, the mid signal/microphone should be patched to the odd channel and the side signal/microphone should be patched to the even channel.

The width control can be adjusted in 1% increments from Mono (0%) to Stereo (100%).

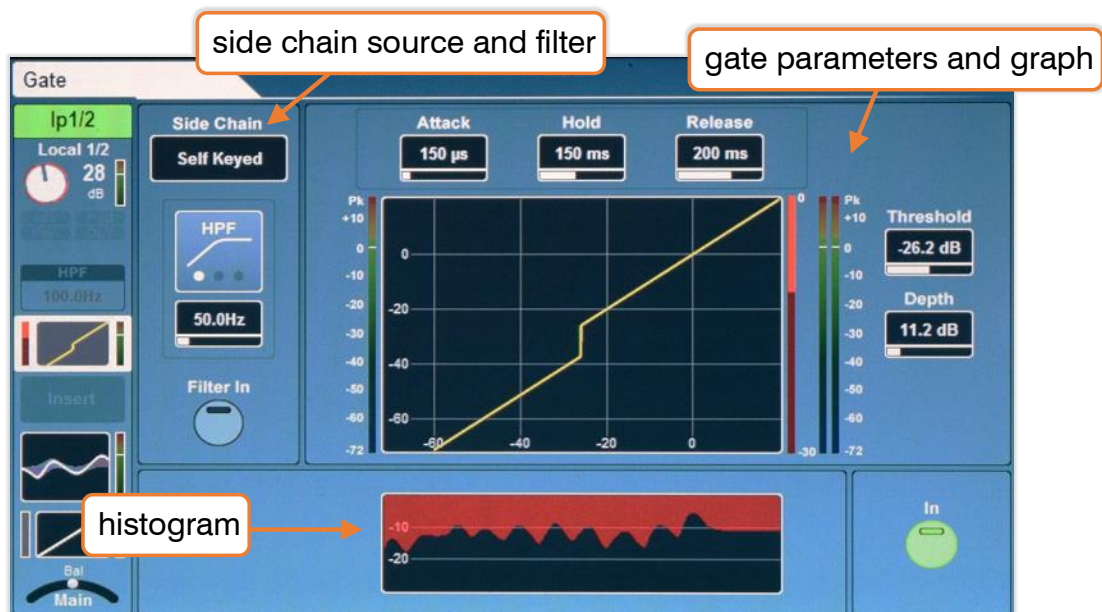

Switch the Gate in or out using either the on-screen 'In' button or the physical Gate 'In' key (to the left of the dedicated Gate threshold rotary).

#### Side Chain –

- Select either '**Self Keyed**' or side chain the gate from another channel.
- Touch the filter type to switch between HPF/BPF/LPF modes. The '**Filter In**' button engages the filter.
- Touch the frequency value to select it, then adjust with the touchscreen rotary.

HPF Frequency = 20Hz to 5kHz  
 BPF Frequency = 120Hz to 10kHz  
 LPF Frequency = 120Hz to 20kHz

#### Parameters and graph –

- The graph displays input/threshold on the x-axis and output level on the y-axis to give a visual representation of gate parameter settings.
- The side chain input level is shown on the meter to the left of the graph. Gate action (signal reduction) from 0dB to -30dB is shown on the meter to the immediate right of the graph. When the gate is switched in, this is red, otherwise it is white.  
 The post-gate level is shown to the right of this.

- Adjust parameters by touching to select and then using the touchscreen rotary. Gate threshold also has a dedicated rotary.

Attack = 50µs to 300ms  
 Hold = 10ms to 5secs  
 Release = 10ms to 1sec  
 Threshold = -72dB to +18dB  
 Depth = 0dB to 60dB

**Histogram** – The histogram shows the previous 12 seconds of gate activity, moving from right to left. As with the reduction meter, when the gate is in, the level reduction (depth) is shown in red, and when out is shown in white/grey.

### 7.3 Insert

The insert points on SQ can be used to route audio to and from any available I/O sockets, allowing external analogue or digital processing to be run ‘in-line’.

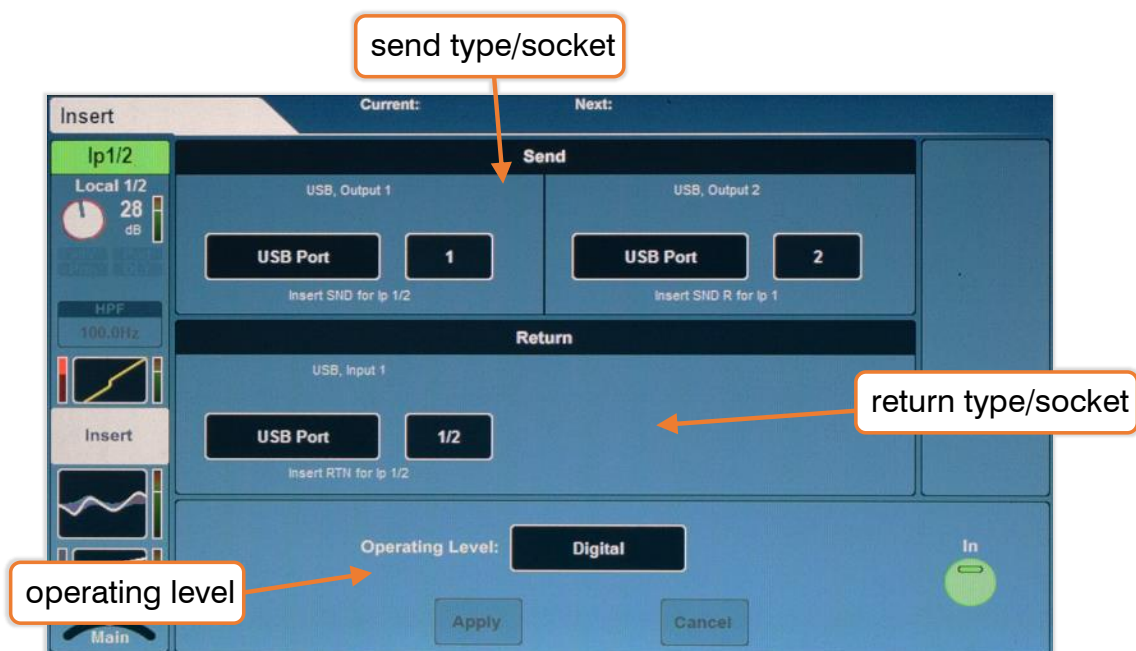

They can also be used with the internal FX engines. See the [FX engine](#) section for more details on this.

Send – Select destination type and channel for the insert send.

Return – Select source type and channel for the insert return.

Send/Return types = Local Socket, SLink Socket, USB Port, IO Port, FX Unit

Operating level – Select from line level options to match insert type.

Digital = Uncompensated, for use with digital I/O.

Analogue = For use with +4dBu outboard equipment.

-10 dBV = For use with -10dBV outboard equipment.

When a selected channel's insert is assigned and switched 'In', the 'Insert Active' LED will illuminate on the SQ surface.

 Note that insert send and return is not latency compensated.



## 7.4 GEQ (mix channels)

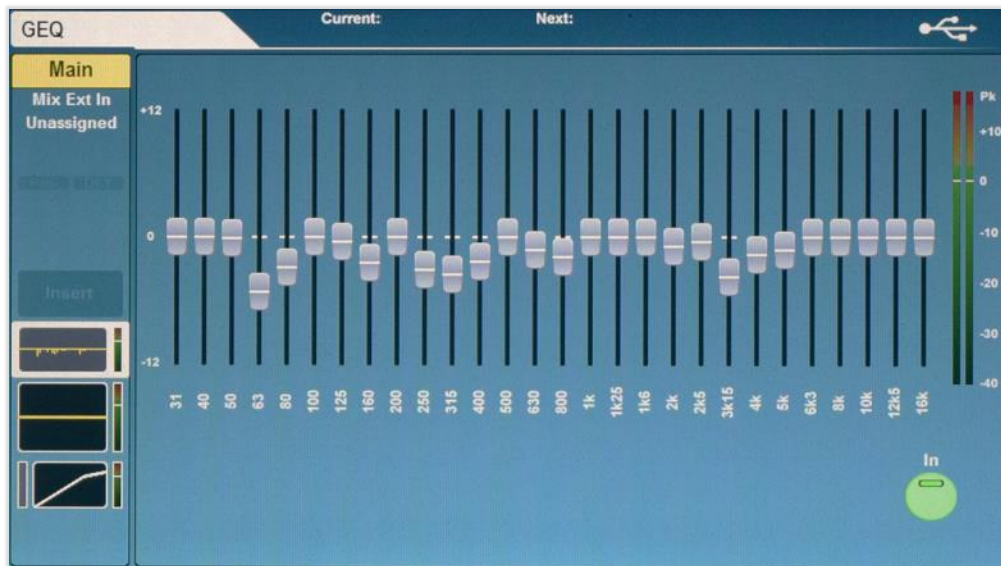

All mix channels feature a 28-band stereo graphic EQ. With a mix channel selected, and GEQ active, the green 'In' LED in the GEQ section (below the PEQ rotaries) will illuminate.

To make adjustments, touch the on-screen fader for each band and use the touchscreen rotary.

Frequencies (Hz) = 31, 40, 50, 63, 80, 100, 125, 160, 200, 250, 315, 400, 500, 630, 800, 1k, 1.25k, 1.6k, 2k, 2.5k, 3.15k, 4k, 5k, 6.3k, 8k, 10k, 12.5k, 16k  
Gain = -12dB to +12dB  
Bandwidth = 1/3<sup>rd</sup> oct (constant)

'Fader Flip' mode - The SQ can also display the GEQ on faders, to allow for quick and accurate adjustment.

- Pressing the GEQ '**Fader Flip**' key shows the graphic EQ on faders, with a frequency band on each fader strip. Pressing the '**Fader Flip**' key a second time displays another set of frequency bands, and a third press will exit the mode.
- Frequencies are displayed on the channel LCD displays.
- The RTA levels (fed from the PAFL bus) are displayed for each frequency using the Chromatic Channel Metering.
- The RTA prominent frequency is displayed using the '**Pk**' LED's, to aid with feedback frequency detection.

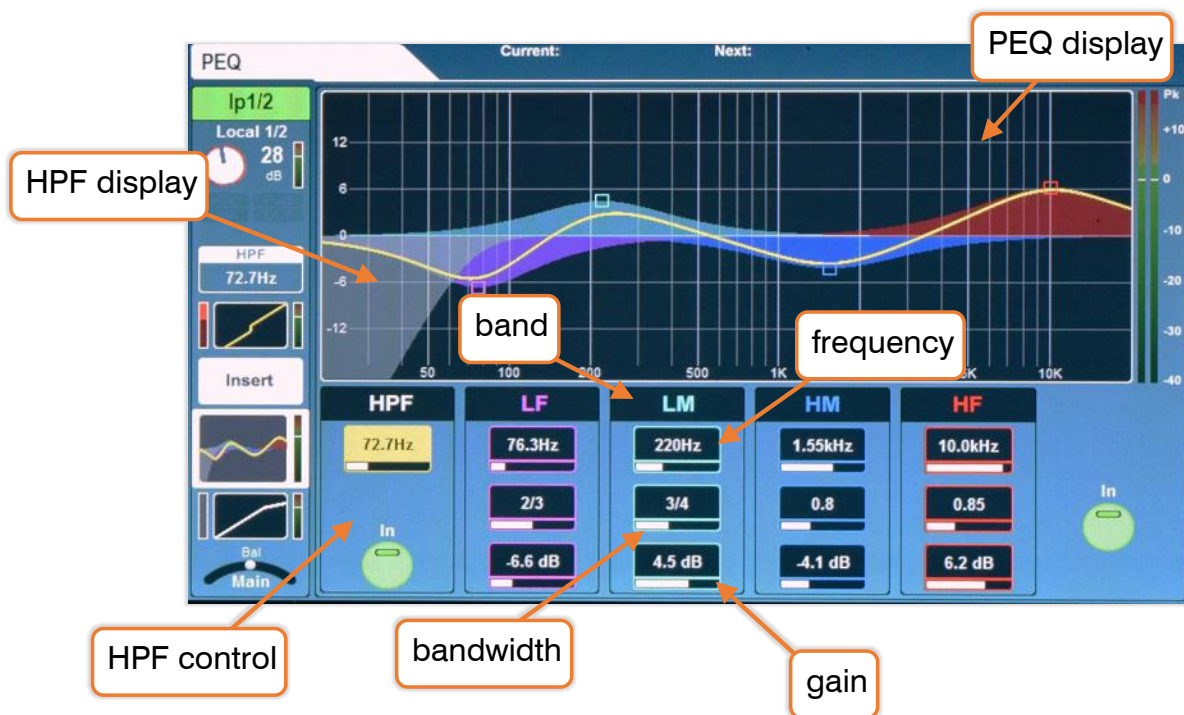

**HPF** - In order of processing, the High Pass Filter (HPF) is located post-preamp (as in the channel overview). It is displayed in the EQ screen for convenience.

- Switch in or out using the on-screen button, or dedicated HPF 'In' key.
- Touch the HPF value to select it, then adjust it using the touchscreen rotary, or use the dedicated HPF rotary.

HPF Frequency = 20Hz to 2KHz

**PEQ** -

- The 4-bands of the parametric EQ are labelled to match the physical EQ section on the surface.
- When the PEQ is active, the graphical display is brightly coloured, when inactive, it is greyed out.
- To use the dedicated physical EQ controls, select a band, and use the gain, bandwidth and frequency rotaries to adjust. To adjust on-screen, touch the parameter and use the touchscreen rotary.

Frequency (all bands) = 20Hz to 20kHz  
 Width (LF, HF) = Shelf, 1.5 oct to 1/9<sup>th</sup> oct  
 Width (LM, HM) = 1.5 oct to 1/9<sup>th</sup> oct  
 Gain (all bands) = -15dB to +15dB

- ⓘ Note that, to avoid accidental switching, the 'Shelf' modes of the LF and HF bands can only be accessed by adjusting the bandwidth/Q control past '1.5' on-screen. It is not possible to set this using the dedicated physical 'Width' rotary.

## 7.6 Compressor

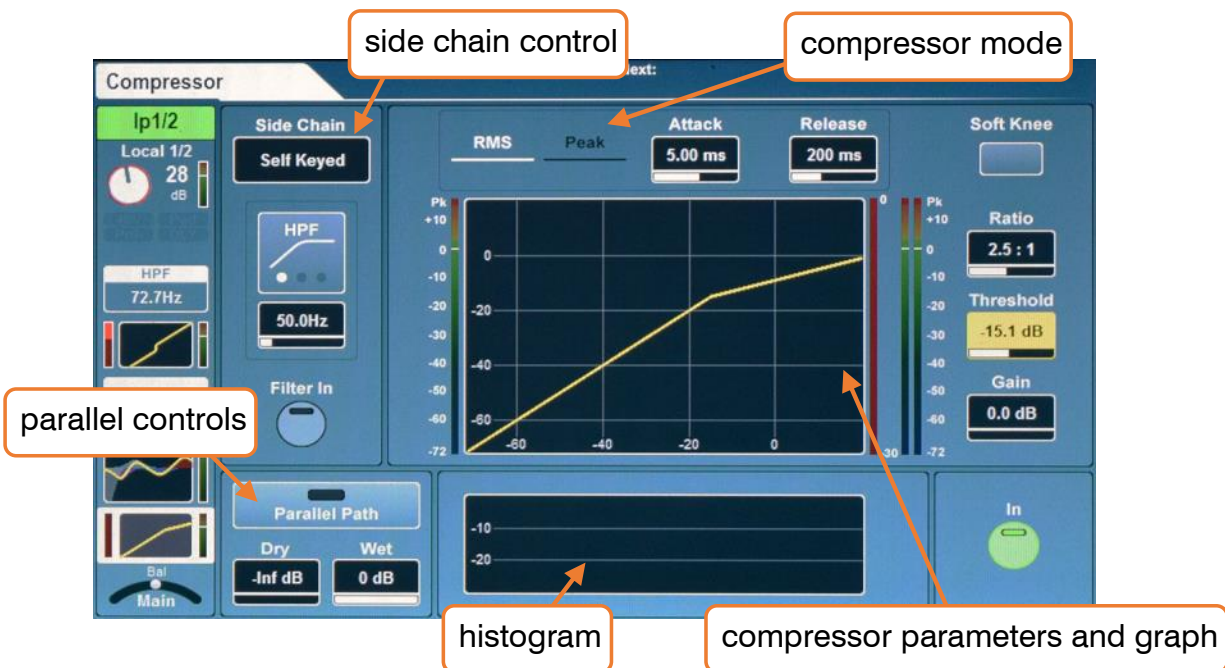

Switch the Compressor in or out using either the on-screen 'In' button or the physical Compressor 'In' key (to the left of the dedicated Compressor threshold rotary).

### Side Chain –

- Select either '**Self Keyed**' or side chain the compressor from another channel.
- Touch the filter type to switch between HPF/BPF/LPF modes.
- Touch the frequency to select, then adjust using the touchscreen rotary.

HPF Frequency = 20Hz to 5kHz  
BPF Frequency = 120Hz to 10kHz  
LPF Frequency = 120Hz to 20kHz

### Compressor mode -

There are two detection modes, RMS (average) and Peak modes. Touch the modes to switch between them. The active mode is displayed in white.

### Soft Knee –

Touch this button to switch on the soft knee setting. This enables a variable ratio which smooths the behaviour of compression around the threshold (this is also displayed on the graph).

## Parameters –

- Adjust parameters by touching to select and then using the touchscreen rotary.

Attack = 30 $\mu$ s to 300ms

Release = 50ms to 2secs

Ratio = 1:1 (no compression) to Infinity (limiting)

Threshold = -46dB to +18dB

Gain (make-up gain) = 0dB to +18dB

## Graph –

- The graph displays input/threshold on the x-axis and output level on the y-axis to give a visual representation of compressor parameter settings.
- The side chain input level is shown on the meter to the left of the graph. Compression (signal reduction) from 0dB to -30dB is shown on the meter to the immediate right of the graph. When the compressor is switched in, this is red, otherwise it is white.  
The post-compressor level is shown to the right of this.

Histogram – The histogram shows the previous 12 seconds of compressor activity, moving from right to left. As with the level reduction meter, when the compressor is in, the level reduction (depth) is shown in red, and when out is shown in white/grey.

Parallel compression – This allows you to blend (in-line) the compressed signal with the uncompressed signal.

- Touch the '**Parallel Path**' button to switch in or out.
- Touch the Dry/Wet values and adjust using the touchscreen rotary.

Dry/Wet individual level = -infinity to 0dB

## 8. Routing

Press any **'Sel'** key to select a channel, then press the **'Routing'** screen key to display the routing 'bank view'. This shows an overview of 8 channels at once, with the selected channel highlighted.

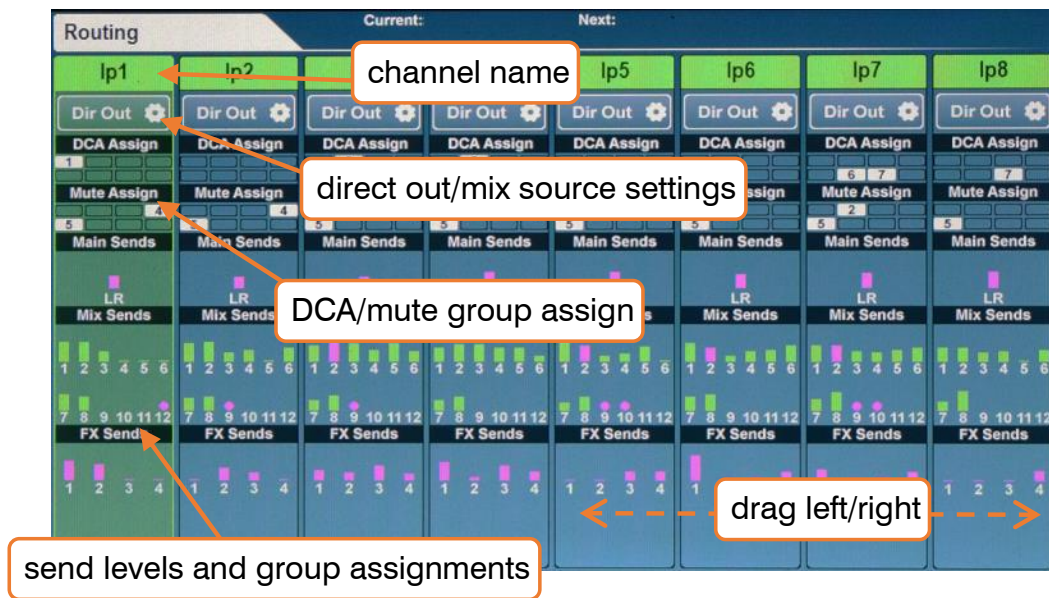

If a channel is assigned to a DCA or Mute group, this is shown with a filled, numbered icon.

Send levels are displayed for Main/LR, Aux sends and FX sends. These are displayed as a filled bar if assigned, and an outline if unassigned. The bar is coloured pink for post-fade and green for pre-fade.

If a mix has been configured as a group, and the channel is assigned to the group, this is shown with a small circle.

The 8 channels shown will automatically adjust if a different channel is selected, though you can also drag left or right to see other channels in the layer.

- Touch a channel name to rename.
  - Touch the **'Dir Out'** button to see the direct out settings.
  - Touch the DCA/Mute Assign 'blocks' to see assignments.
  - Touch anywhere in the Main/Mix/FX Send levels to see detailed send information for that channel.
- ⓘ Mix channels also display the 'Matrix Sends' block at the bottom of the channel overview.
- ⓘ Matrix channels display their source levels rather than send levels.
- ⓘ DCA channels display a list of up to 28 'members'. If there are more members than this, then '...' will appear at the bottom of the list.

## 8.1 Direct out

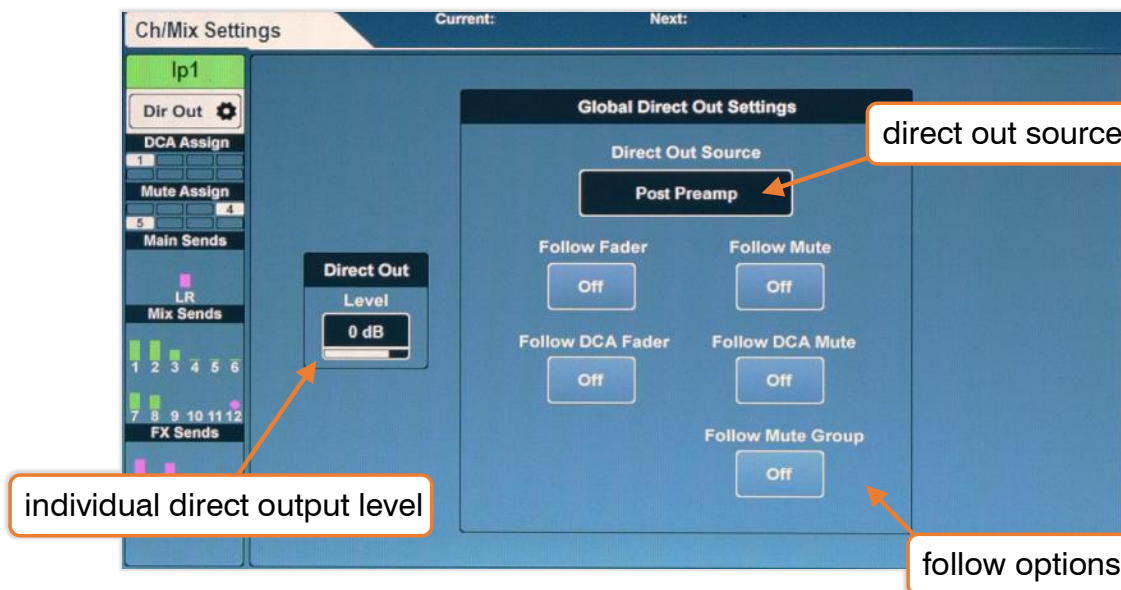

This screen shows the direct output level for the selected channel, as well as the global direct out settings which affect all channels. The currently selected channel is displayed on the left.

- Touch the level value and adjust using the touchscreen rotary, this is adjusted individually on each channel.

Direct out level = -inf to +10dB

- Choose whether direct out signals are affected by faders or mutes by touching the on-screen buttons.
- Select the channel 'tap off' point by touching the Direct Out Source value. Each source point is presented in order, and is affected by all preceding processing that is switched in.

Post Preamp = signal is affected only by the preamp gain.

Post HPF = signal is also affected by the high pass filter.

Post Gate = signal is also affected by the gate.

Post Insert Return = signal is also affected by the insert.

Post PEQ = signal is also affected by PEQ.

Post Comp = signal is also affected by compressor.

Post Delay = signal is affected by all channel processing including ms delay.

Mix channels have different buttons in place of the '**Dir Out**' button found on the input channels, touch this to see the following options.

### Main – ('**Main Snd**')

- Touch the '**Output Bal**' value and adjust using the touchscreen rotary to adjust the output balance.

### Group – ('**Group**')

- Touch the '**Output Bal**' value and adjust using the touchscreen rotary to adjust the output balance.
- Touch '**All On**' or '**All Off**' button to assign or unassign all channels to the group.

### Aux – ('**Aux Snd**')

- Touch the '**Channel Source**' value to choose the where the aux takes channel signal from. Each source point is presented in order, and is affected by all preceding processing that is switched in.

Post Preamp = signal is affected only by the preamp gain.

Post Insert Return = signal is also affected by HPF, gate and insert.

Post EQ = signal is also affected by PEQ.

Post Delay = signal is affected by all channel processing including ms delay.

- Touch '**All On**' or '**All Off**' button to assign or unassign all channels to the aux.
- Touch '**All Pre**' or '**All Post**' button to set all channel sends to pre-fade or post-fade.

### FX – ('**FX Snd**')

- Touch the '**Channel Source**' value to choose the where the FX send bus takes channel signal from. Each source point is presented in order, and is affected by all preceding processing that is switched in.

Post Preamp = signal is affected only by the preamp gain.

Post Insert Return = signal is also affected by HPF, gate and insert.

Post EQ = signal is also affected by PEQ.

Post Delay = signal is affected by all channel processing including ms delay.

- Touch '**All On**' or '**All Off**' button to assign or unassign all channels to the FX bus.
- Touch '**All Pre**' or '**All Post**' button to set all channel sends to pre-fade or post-fade.

## 8.3 DCA/Mute Groups

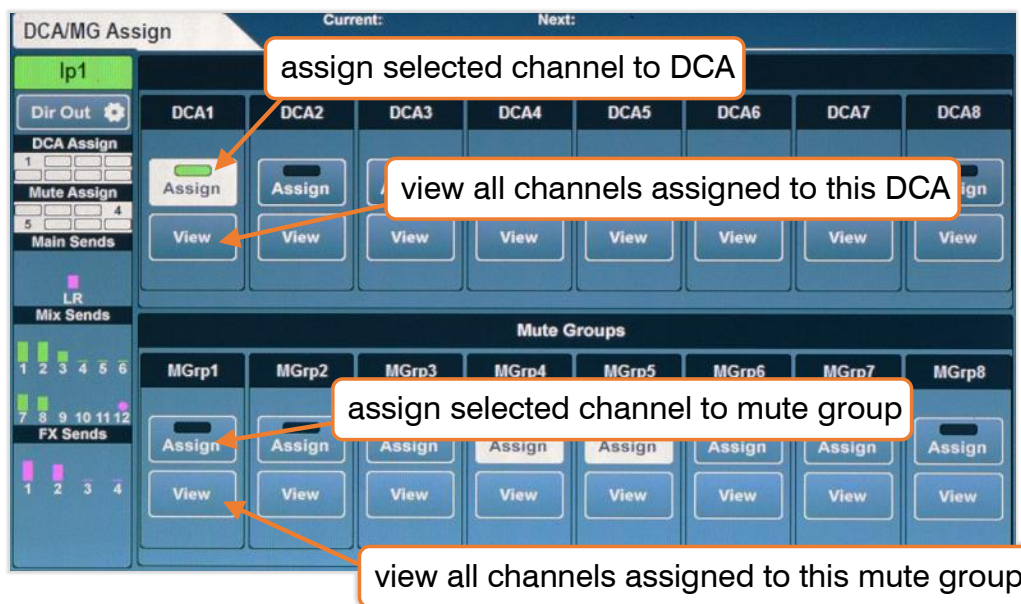

All DCA and Mute Group assignments for the selected channel are displayed, with the currently selected channel displayed to the left.

- Touch '**Assign**' buttons to assign or unassign the selected channel to DCA's or Mute Groups.

Touch the '**View**' buttons to see all channels currently assigned to the DCA or Mute Group.

- Touch and drag in this window to see all channels.
- Channels can be assigned or unassigned by touching assignment buttons.
- Touch the DCA/Mute Assign 'blocks' to return to the selected channel assignments view.

In both the '**Processing**' and '**Routing**' screens, DCA channels display a list of up to 28 channel 'Members' (channels assigned to that DCA). If there are more members than this, then '...' will appear at the bottom of the list.

- Touch anywhere on a DCA member list to view and assign or unassign channels.

**i** When muting DCA's or Mute Groups, the mute keys of the assigned channels will flash.



## 8.4 Send levels and mix assignments

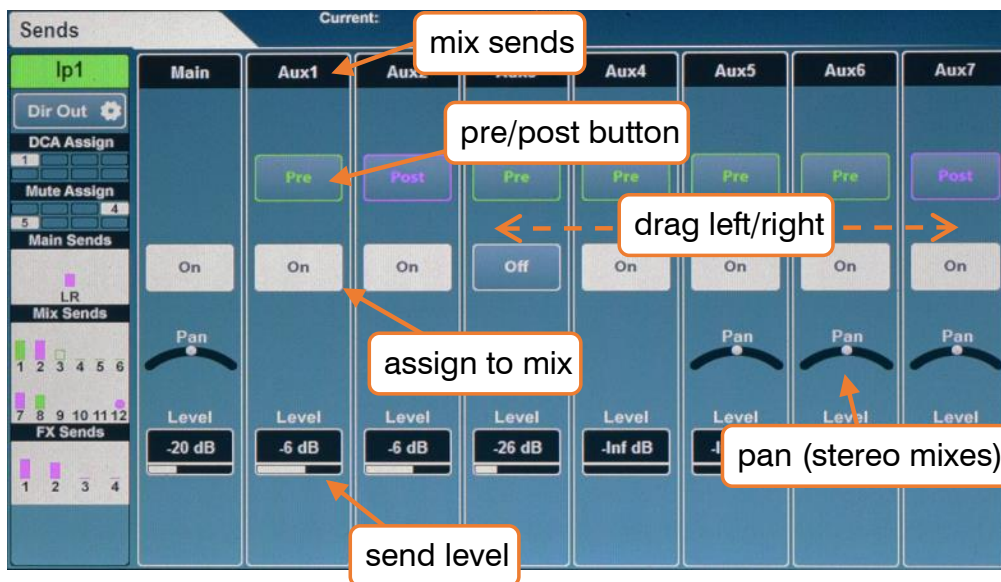

This screen displays all sends and mix assignments for the selected channel.

- Touch and drag left or right to view all mixes and sends.
  - Touch the 'On/Off' button to assign or unassign the channel to a mix/send or matrix.
  - Touch the 'Pre/Post' button to set send to either Pre-fade or Post-fade.
  - Touch the 'Pan/Bal' control and use the touchscreen rotary to set the pan or balance for a send.
  - Touch the 'Level' value and adjust using the touchscreen rotary, or adjust on faders.
- i** Pressing the momentary 'CH to All Mix' key displays all send levels for the currently selected channel on the fader strips. You can also hold this key then hold the assign or pre-fade keys.

## 8.4 Assigning a mix to a matrix

There are three methods for sending a mix to a matrix.

- 1) The matrix sends are shown in the send levels and assignments screen when a mix is selected.
- 2) The matrix sources are shown in the send levels and assignments screen when a matrix is selected.
- 3) The matrix sends are shown on faders when a mix channel is selected and the momentary 'CH to All Mix' key is pressed on the surface of the SQ.

## 9. Metering

### 9.1 PAFL LED Meter

The 12 segment LED metering on the surface of the SQ to the right of the touchscreen displays level metering for the PAFL bus.

By default, with no PAFL keys active, this displays the main LR mix level.

- ❗ The PAFL LED indicator below the 12 segment LED illuminates when a PAFL routing key or button is active anywhere in the mixer.

### 9.2 Input/FX/Output Meters

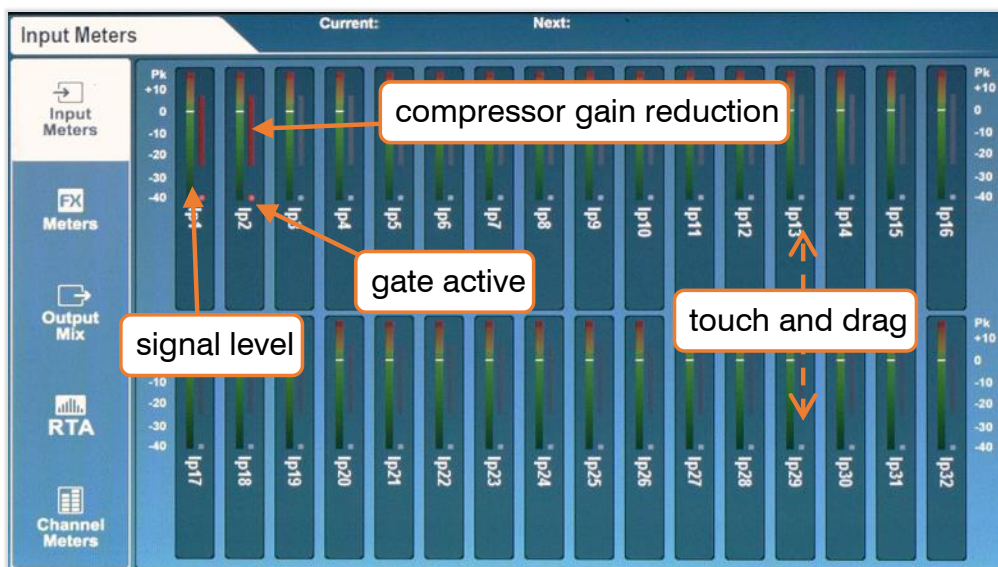

The first three tabs on the **'Meters'** screen show **'Input Meters'**, **'FX Meters'** and **'Output Meters'**.

- The main coloured meter displays levels from -40dB to +10dB.
- The gain reduction meter shows level reduction from 0dB to -30dB, this is red/bright red when the compressor is switched in and grey/white when it is switched out.
- The gate active indicator is red/bright red when the gate is switched in and grey/white when the gate is switched out.
- Touch and drag to view other channels.

- ❗ Input meters display post processing level.

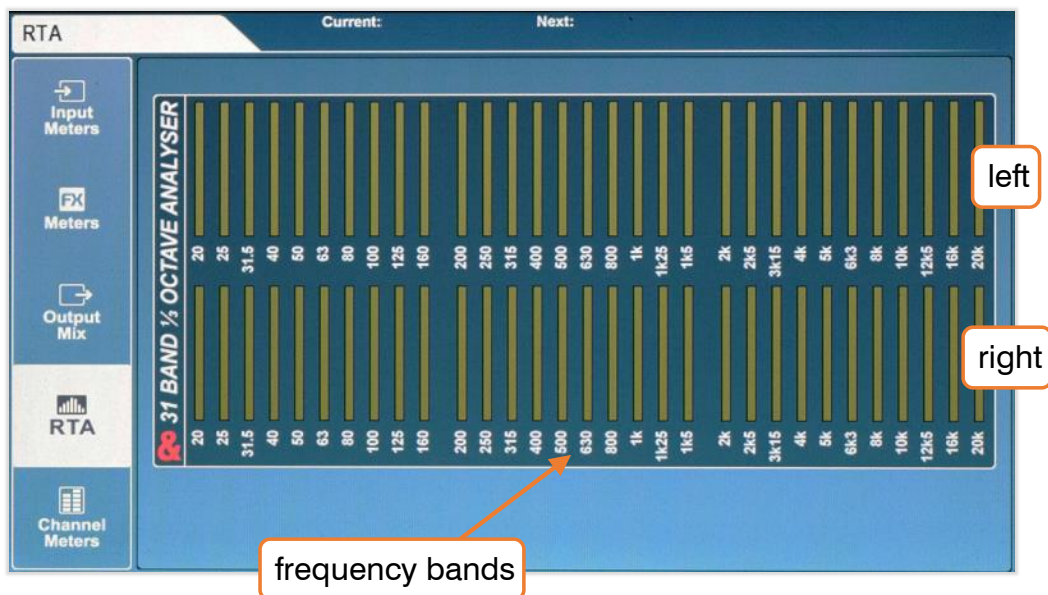

- RTA follows PAFL selection and settings.
- Displays the levels of 31 frequencies with fixed 1/3<sup>rd</sup> oct bandwidth.
- The meter for the prominent frequency of either left or right is shown in red.

System setup - By connecting a measurement microphone and 'listening' on the PAFL bus, the RTA meters can be used to analyse a room.

Ringing out a room – The RTA can be used to find problem frequencies in channels/groups/mixes. Used in conjunction with PEQ and GEQ, it is easy to reduce the level of frequencies from outputs that may be causing feedback.

ⓘ See also [GEQ 'Fader Flip' mode](#), which displays the RTA using channel metering.

## 9.4 Other Metering

- More detailed metering is also displayed throughout the processing screens and is particularly useful for gain staging with each processing 'block'.
- The peak (Pk) LED's on channels strips use multi-point sensing to display destructive peaking anywhere in the channel or mix.
- If a channel is peaking on a channel strip which is on an inactive layer, the layer selection key will illuminate in red.
- SQ-Drive metering displays either the signal being sent to, or the signal returning from the SQ-Drive, depending on its state (recording/playback).

## 9.5 Chromatic Channel Metering

The Chromatic Channel Metering displays the information of a high-resolution meter in the space of a single LED. It can depict a much greater range of levels than a traditional meter and behaviour is customisable in the 'Channel Meters' tab.

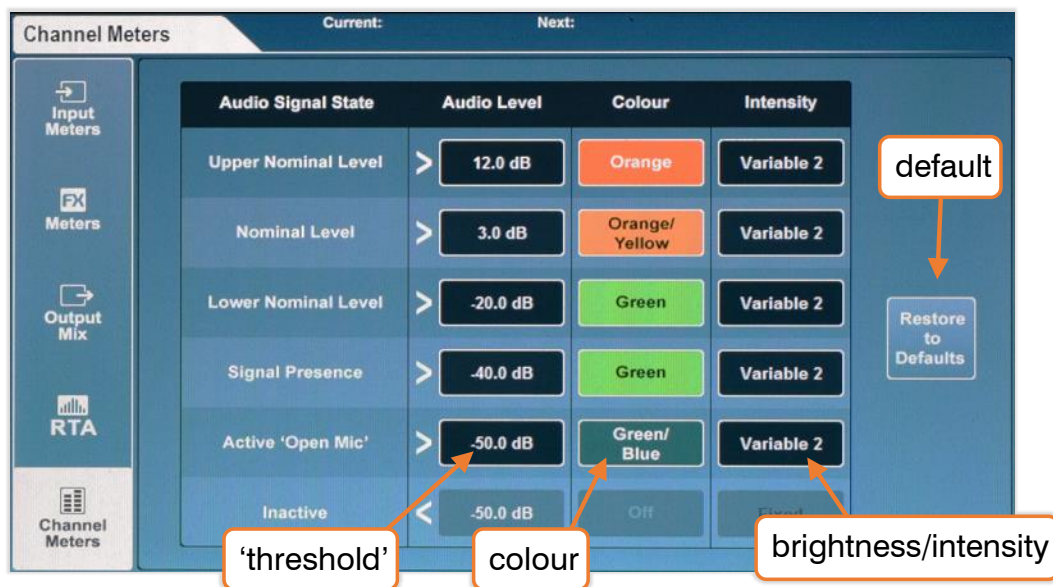

- Touch an '**Audio Level**' value and adjust using the touchscreen rotary.
- **i** '**Audio Level**' values are bound by the level setting of states above and below.
- Touch a colour for an '**Audio Signal State**' and use the touchscreen rotary to adjust the colour/s for this level range.

Colours = White, Red, Orange, Orange/Yellow, Yellow, Green, Green/Blue, Blue, Blue/Red, Off.

- Touch the '**Intensity**' value to choose the behaviour of the meters.

Fixed = meter switches instantly between states.

Variable 1 = meter changes close to the endpoints of its range.

Variable 2 = meter changes across the whole range.

- Touch the '**Restore to Defaults**' button to restore settings.

Upper Nominal	>	+12.0dB	Orange	Variable 2
Nominal	>	+3.0dB	Orange/Yellow	Variable 2
Lower Nominal	>	-20.0dB	Green	Variable 2
Signal Presence	>	-40.0dB	Green	Variable 2
Open Mic	>	-50.0dB	Green/Blue	Variable 2
Inactive	<	N/A	N/A	N/A

## 10. FX Engines

### 10.1 Using FX buses and returns

The SQ has four FX send buses which, in SQ's default state, send to the first four FX engine slots (these are preloaded with useful FX pre-sets).

These buses can be used in the same way as any of the mix buses:

- Press an FX key from 1 to 4 to show and adjust the send levels on faders for each fader strip to that FX bus.
- With a channel selected, hold the '**CH to All Mix**' key to show and adjust all FX bus sends for the selected channel (along with all other sends).
- The master send level is shown on the Master channel.

The FX output signal is returned to the matching FX return channel for each FX engine slot. (i.e. '**FX Unit 1**' output is routed to '**Fx1Rtn**').

- All FX return channels are stereo and feature PEQ processing.
  - FX Returns can be assigned and sent to mixes in the same way as any input channel.
- i** FX return channels can be assigned to fader strips, but will not be visible unless they are routed from the output of the FX engine (e.g. set as '**Mix -> Return**' on the back panel).

## 10.2 Loading units and pre-sets

Pressing the 'FX' screen key displays the front/rear of the currently selected FX engine, with other loaded FX units and empty slots on the left of the screen.



- Select the slot you wish to use.
- Press the 'Library' key on the surface to open the FX Library.
- Select a 'Factory' pre-set and use the touchscreen rotary to scroll through the full list. (listed alphabetically). Different pre-sets use different FX units.
- Touch the 'Recall' button to recall the pre-set.

**i** User pre-sets can be stored and recalled to and from the 'User' section of the FX library.

## 10.3 Adjusting parameters

Each FX unit has a different set of parameters, but all work in the same way.

- Touch any buttons to switch between modes or states.
- Touch parameter controls or values and use the touchscreen rotary to adjust.

The SMR unit is a special case - pressing the 'Expert' button will give access to much more in-depth control for fine tuning reverb behaviour. In this mode, cycle through all parameter settings using the 'Page' button.

## 10.4 Sending to FX from other sources

**Mix->Return** - As well as sending using the four FX buses, you can send to the FX engines using mixes, allowing you to send to any of the 8 FX engines using 'sends on faders'. This routing type can also be used with channel direct outs.

For any adjustment to routing first press the '**Back Panel**' button at the top right of the FX screen.

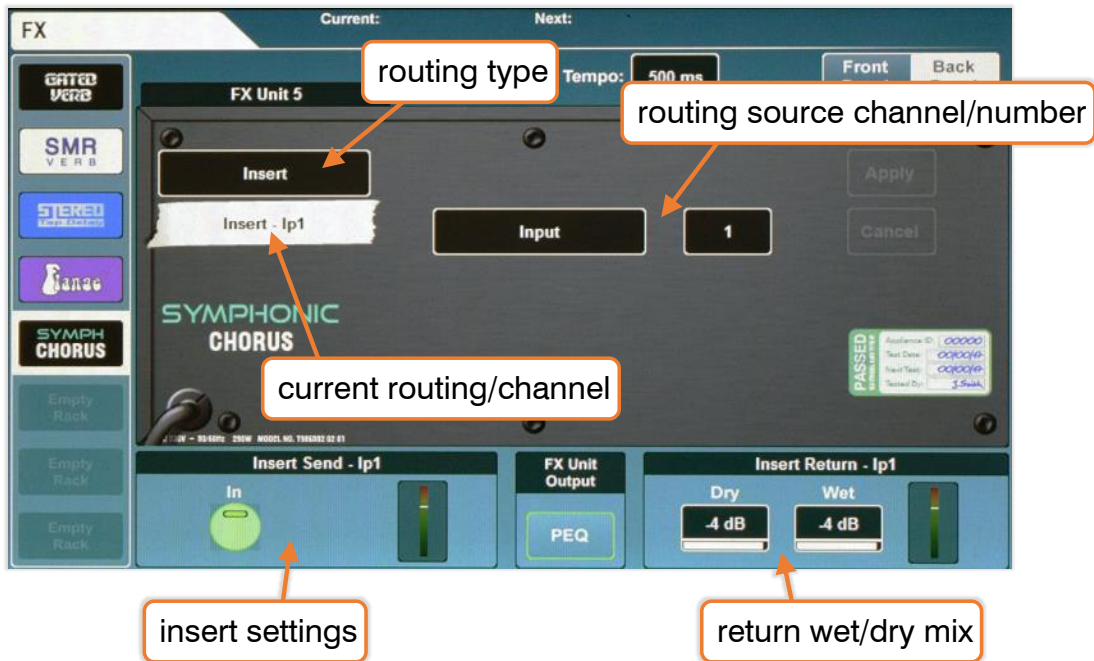

- 1) Set the routing type to '**Mix -> Return**'.
- 2) Touch the routing source value to select a source.

Sources = FX Send, Group, Aux, Main, Matrix, Direct Output

- 3) Touch the channel value and adjust using the touchscreen rotary.
- 4) Touch the '**Apply**' button to apply changes.

**Inserts** – You can insert FX engines on individual channels or mixes. This automatically sets up and uses the insert point of the channel.

- 1) Set the routing type to '**Insert**'.
- 2) Touch the routing source value to select a source.

Sources = Input, Group, Aux, Main, Matrix

- 3) Touch the channel value and adjust using the touchscreen rotary.
- 4) Touch the '**Apply**' button to apply changes.

When routed as '**Mix -> Return**', the PAFL, Mute and Level settings for the currently selected FX engine slot are displayed at the bottom of the screen for both the FX send and FX return.

- Touch buttons to PAFL or mute channels.
- Touch values and adjust using the touchscreen rotary.

When an FX engine is being used as an insert, the insert '**In**' button and return wet/dry mix values are displayed.

- Touch the '**In**' button to switch the insert in or out.
- Touch either wet or dry values to adjust the blend of the dry (unprocessed) signal with the wet (processed) signal.

Dry/Wet individual level = -infinity to 0dB

Press the PEQ button at the bottom centre of the screen to view and adjust the PEQ which affects the output of the FX. This works in exactly the same way as any channel processing PEQ.

- ⓘ All level and PEQ settings, presented on the FX screen for convenience, duplicate control available elsewhere in the mixer. The PEQ for example, is the same PEQ that can be accessed when selecting FX return channels.



## 11. Saving and Recalling Shows/Scenes

All the settings in SQ can be stored and recalled in either 'Scenes' or 'Show' files. Scenes are intended for recall during use, whilst a Show file contains everything for an event or particular set up. Show files should also be used to backup a configuration or transfer it to another unit.

Saved in each Scene	Saved in each Show
Input and output routing	300 Scenes
Preamp settings	Chromatic Channel Metering
Channel processing	Surface brightness preferences
Channel assignments and send levels	Signal Generator settings
Panning and balance	Talkback settings
Channel mutes	Global scene filter settings
Mute Groups and DCA assignments and levels	Channel safes
Fader strip assignments	MIDI channel
FX units and parameters	Audio Sync settings
Channel names	PAFL settings
SoftKey/SoftRotary assignments	Stereo Input/Mix and Mix Config
Footswitch settings	USB source

Saved in the SQ
Network settings
Unit name
Fader Calibration

In summary:

- A 'Scene' is a snapshot of all mix settings.
- There are 300 scene slots available per 'Show'.
- In addition to all scenes, a 'Show' includes all SQ settings (such as Chromatic Channel Metering and Integrated Surface Illumination settings).

## 11.1 Scene manager

The scene manager allows the storing, recalling and deletion of scenes.

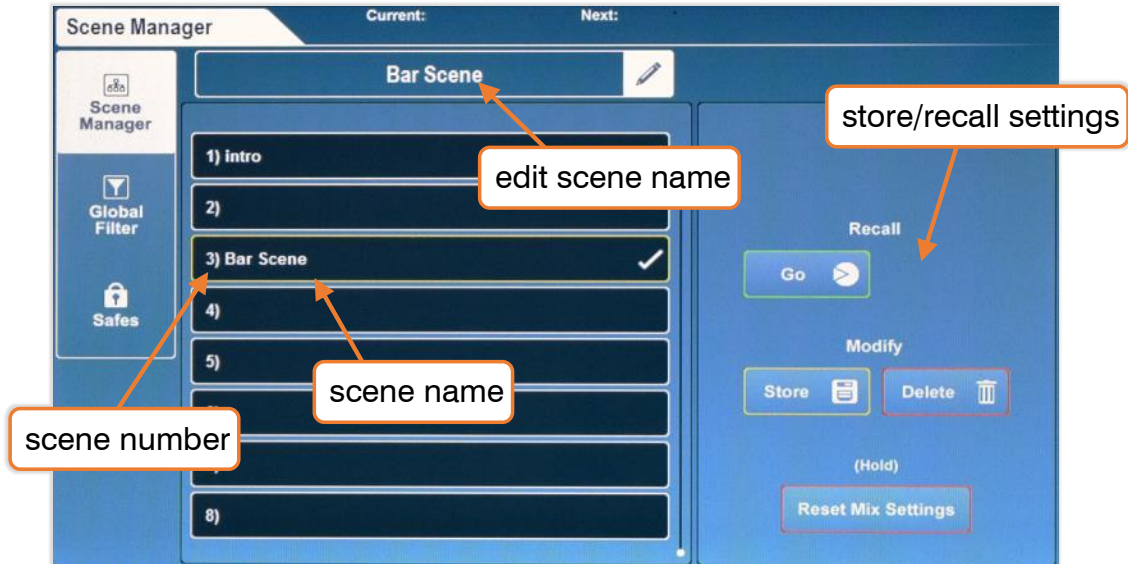

To store all current mix settings in a new slot, touch any empty slot then:

- Touch the '**Store**' button to save with the name 'Scene [x]'.  
OR
- Touch in the empty scene name field to be prompted to name the scene at the same time as storing it.

To recall a scene

- Touch a scene to highlight it (use the touchscreen rotary to change selection or scroll through all scenes) then touch the '**Go**' button.

To rename a scene:

- Touch the scene, then touch in the edit scene name field at the top of the screen.

To overwrite a scene:

- Touch the scene to overwrite, then touch the '**Store**' button.

To delete a scene:

- Touch the scene you wish to delete then touch the '**Delete**' button.

## 11.2 Global Filter

Global scene filters are always active, and affect which settings are changed when recalling a scene.



- Touch any filter button to switch between 'Allow' and 'Block'.
- Blocked parameters will not be affected when recalling scenes.
- ⓘ It is common to block 'Talkback Preamp', 'SoftKeys' and 'SoftRotaries', so they continue to function in the same way whenever scenes are recalled.
- Use the 'All' button to switch all filters at once.

## 11.3 Safes

'Safes' block any changes to a channel when recalling a scene.



- Touch 'Input', 'FX' or 'Mix' tabs to view all channel safes.
- Touch a 'Safe' button to safe the channel (the button will turn white).

## 11.4 Show manager (USB)

A 'Show' allows you to store all SQ settings and scenes at once, and is used to back-up the mixer settings, or transfer them to another SQ, using SQ-Drive.

The show manager is located in the '**Utility**' screen, in the '**USB Data**' tab.

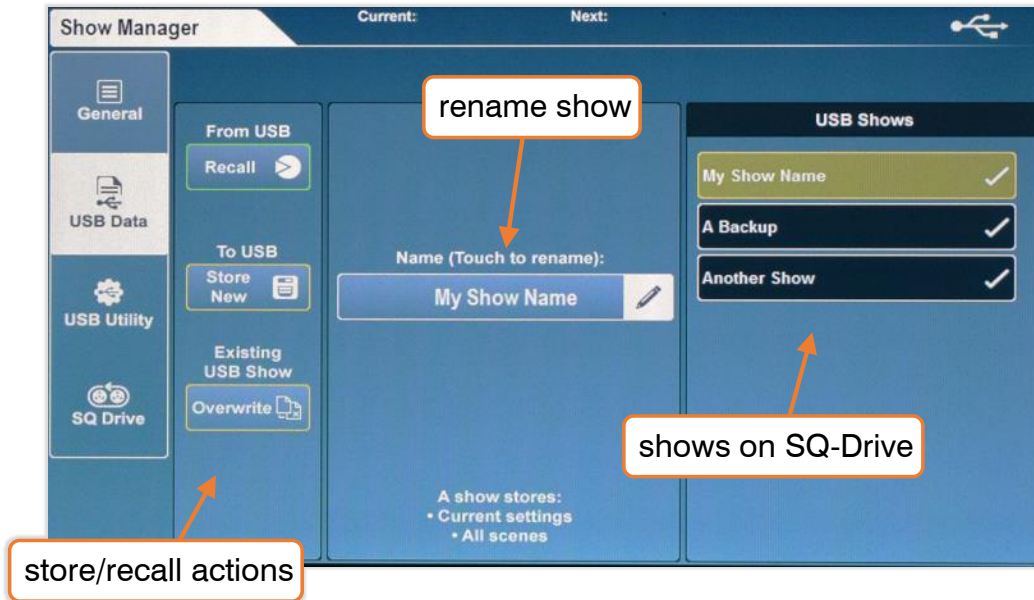

To store a show to a USB device:

- Touch the '**Store New**' button, you will be prompted to name the show.

To recall a show

- Touch a show to highlight it (use the touchscreen rotary to change selection or scroll through all shows) then touch the '**Recall**' button.

To rename a scene:

- Touch a show, then touch in the '**Name**' field in the centre of the screen.

To overwrite a scene:

- Touch the scene to overwrite, then touch the '**Overwrite**' button.

ⓘ Storing or recalling shows is not possible when SQ-Drive is being used for recording or playback.

ⓘ Storing or recalling shows will interrupt USB-B streaming.

## 12. Setup

### 12.1 Strip assign

All fader strips on the SQ are freely assignable.

Press the '**Setup**' screen key, touch the '**Surface**' tab then touch the '**Strip Assign**'

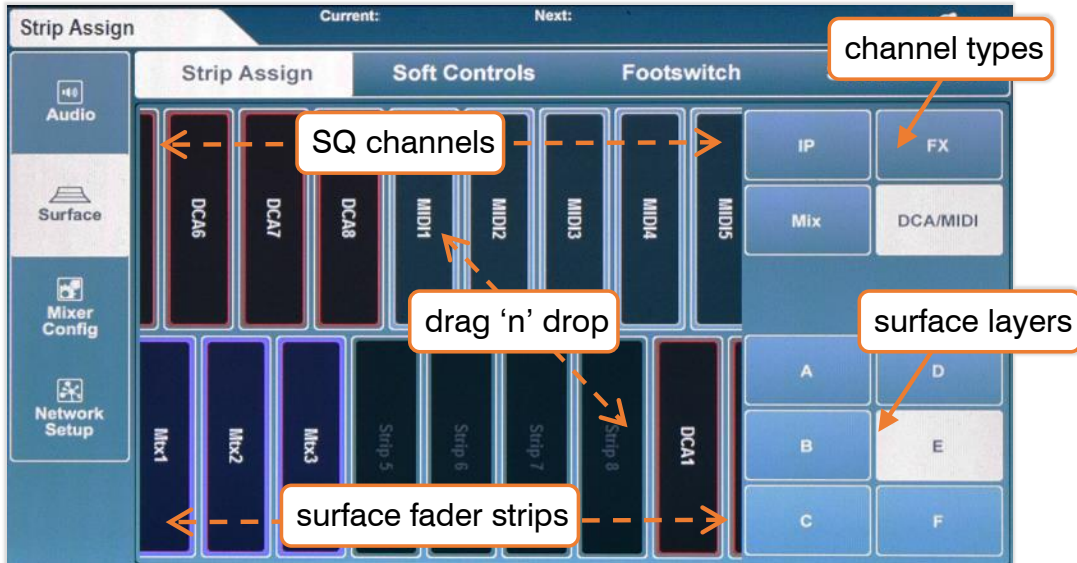

tab.

- SQ channels are displayed in the top half of the screen. Select channel types by touching buttons on the right, and touch and drag left or right to view all available channels.
  - Fader strips are displayed in the bottom half of the screen. Select layers by touching the buttons to the right, and touch and drag left or right to view all available fader strip slots.
  - To assign channels to fader strips, touch and drag them from the top row to a fader strip in the bottom row.
- ⓘ FX return channels can be assigned to fader strips, but will not be visible unless they are routed from the output of the FX engine (e.g. set as '**Mix -> Return**' on the back panel).

## 12.2 Input/Mix stereo assign

To use channels as stereo channels throughout the mixer, they must first be switched into stereo mode.

In the 'Setup' screen, touch the 'Mixer Config' tab, then touch either 'Input Stereo' or 'Mix Stereo'.

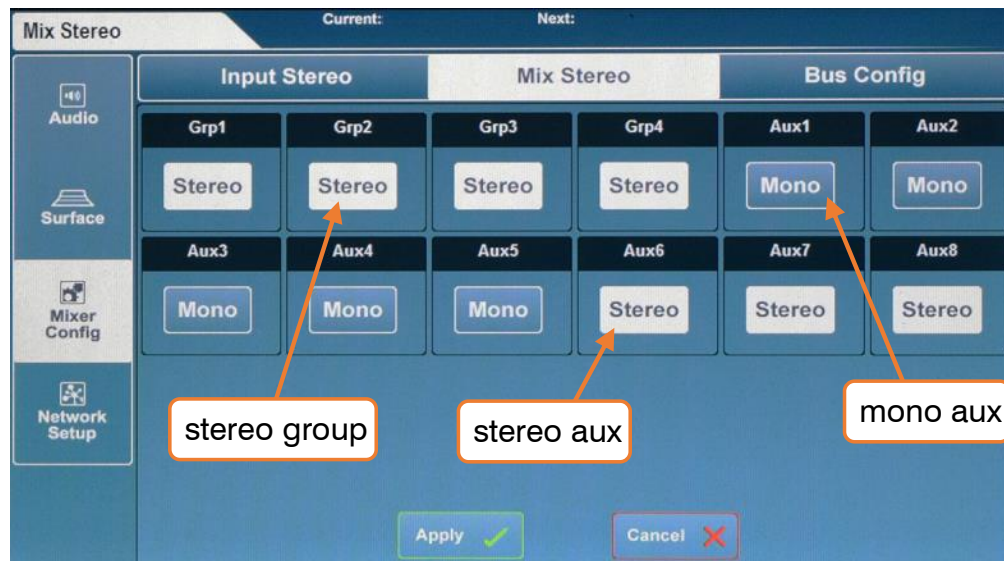

- Odd/even pairs of input channels or any mix can be switched between mono and stereo mode by touching the 'Mono/Stereo' button.
- Touch the 'Apply' button to apply any changes.
- Touch the 'Cancel' button to undo changes and display the current state.

## 12.3 Mix bus configuration

The 12 stereo mixes can be switched between group and auxiliary modes under the **'Bus Config'** tab.

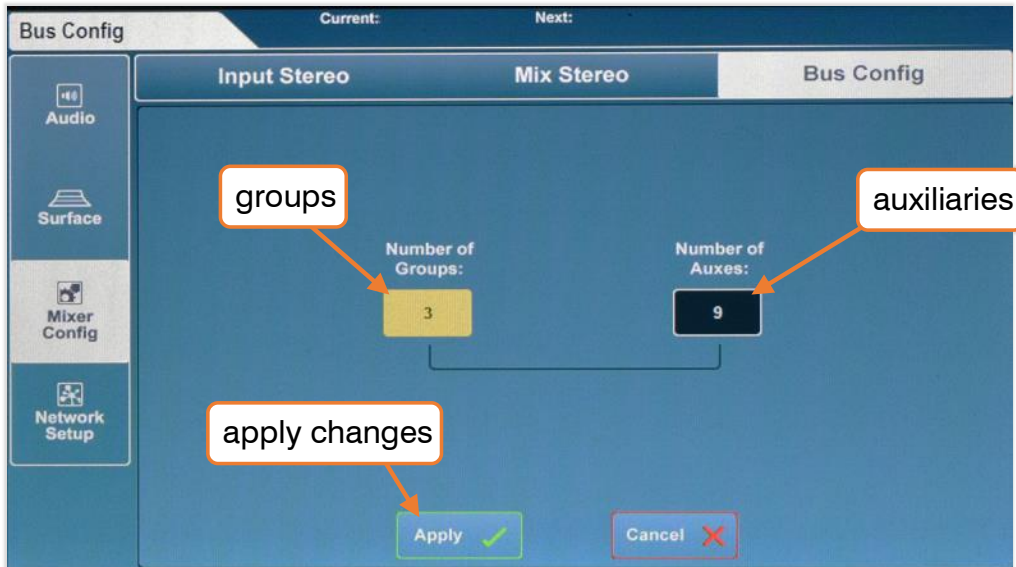

- Touch either the **'Number or Groups'** value or the **'Number of Auxes'** value, then adjust using the touchscreen rotary.
- Increasing the number of groups will decrease the number of auxiliaries and vice versa.
- Touch the **'Apply'** button to apply any changes.

Auxiliaries will always be assigned sequentially to the first mix keys, with groups assigned afterwards. For example, if you configure the buses as 5 groups and 7 auxes, auxes 1 to 7 will be on mix keys 1 to 7 and groups 1 to 5 will be on mix keys 8 to 12.

- **i** Mix keys assigned to auxes illuminate blue when active, and mix keys assigned to groups illuminate magenta.

SoftKeys and SoftRotaries (SQ-6) allow you to customise surface controls of the SQ.

Press the '**Setup**' screen key, then touch the '**Surface**' tab followed by the '**Soft Controls**' tab to view and adjust SoftKey and SoftRotary assignments.

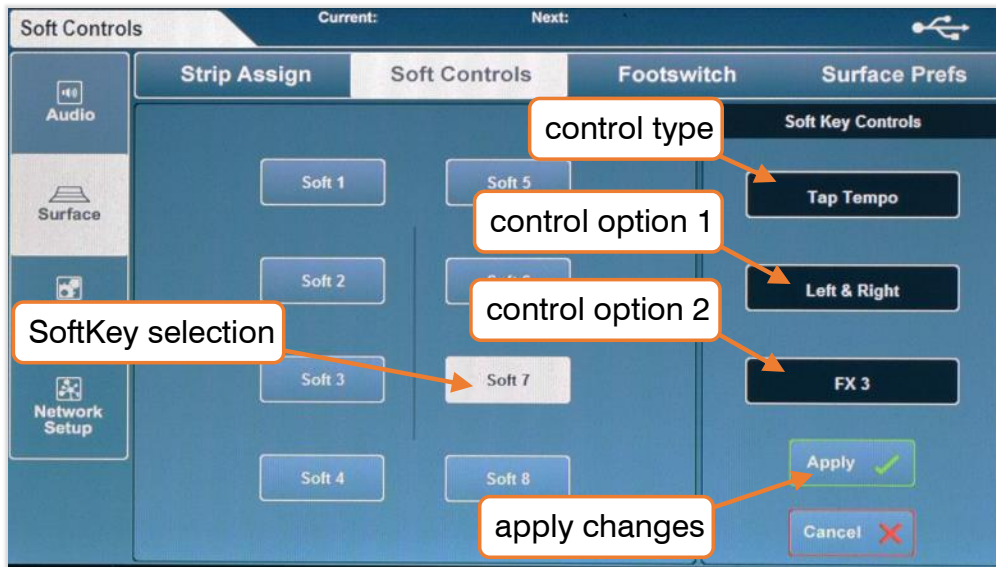

- ❗ When using an SQ-6, two buttons are displayed on-screen to the left of the SoftKey or SoftRotary selection buttons. Touch '**Soft Keys**' or '**Soft Rotaries**' to display and adjust assignments for each.

To change the function of a SoftKey or SoftRotary:

- 1) Touch a numbered SoftKey or SoftRotary button, these match the labelling on the surface of the SQ and turn white when selected.
- 2) Touch the control type value and select a type.
- 3) Touch the control option 1 value (when available) and select an option.
- 4) Touch the control option 2 value and select an option.
- 5) Touch the '**Apply**' or '**Cancel**' button, to apply or disregard any changes.

SoftKeys illuminate with different colours depending on function. When assigned to a Tap Tempo, they flash to display the current tempo.

Each SoftRotary has an LCD display, a key and is illuminated when active.

- The SoftRotary LCD display displays channel or parameter.
- The SoftRotary key works in a different way for each SoftRotary function.
- The colour of the SoftRotary illumination changes depending on current rotary function.



Possible SoftKey assignments			
Control Type	Control Option 1	Control Option 2	Colour
Unassigned	N/A	N/A	N/A
Channel Mute	N/A	All audio channels	Red
Mute Group	N/A	Mute Groups 1 to 8	Red
DCA Mute	N/A	DCA's 1 to 8	Red
Tap Tempo	Left, Right, Left & Right	FX engines 1 to 8	Red
Global Tap Tempo	N/A	N/A	Red
Recall Scene	N/A	All saved scenes	Red
Scene Store Current	N/A	N/A	Red
Scene Recall Go	None, Auto Increment	N/A	Red
Scene Next	N/A	N/A	Red
Scene Previous	N/A	N/A	Red
Channel PAFL	N/A	All audio channels	Yellow
DCA PAFL	N/A	DCA's 1 to 8	Yellow
PAFL Clear	N/A	N/A	Red
SQ-Drive Stereo Play	N/A	Previous, Stop, Start/Pause, Next	N/A
SQ-Drive Stereo Record	N/A	Stop, Start/Pause, Arm	N/A
SQ-Drive Multitrack	N/A	Stop, Start/Pause, Arm	N/A
MMC	N/A	Rewind, Play, Pause, Stop, FFwd, Record	N/A
DAW Control	N/A	Bank Up, Bank Down	N/A
Talkback	N/A	N/A	Green
Mix Select	N/A	All mixes	Blue/Magenta

Possible SoftRotary assignments			
Control Type	Control Option 1	Control Option 2	Key
Unassigned	N/A	N/A	N/A
Main Level Fader	Current Selection, all main send levels	N/A	Mute
DCA Level Fader	DCA's 1 to 8	N/A	Mute
Send Level Fader	All input and mix channels	Main LR, all aux and FX sends	N/A
Pan	All input and mix channels	Main LR, all stereo aux	Centre
Gate	Threshold, Depth, Attack, Hold, Release	Current Selection, all input channels	In/Out
Compressor	Threshold, Ratio, Gain, Attack, Release	Current Selection, all input and mix channels	In/Out
Preamp	Gain, Trim	Current Selection, all input and mix channels	Pad
HPF Frequency	Current Selection, all input channels	N/A	In/Out
PEQ Band	LF, LM, HM, HF	Current Selection, all input and mix channels	Param

## 12.5 Footswitch

Connecting a single or dual, momentary or latching footswitch with a TS or TRS ¼" jack plug to the '**Footswitch**' socket allows hands free control of the SQ.

In the '**Setup**' screen, touch the '**Surface**' tab then the '**Footswitch**' tab to display and adjust the footswitch settings and assignments.

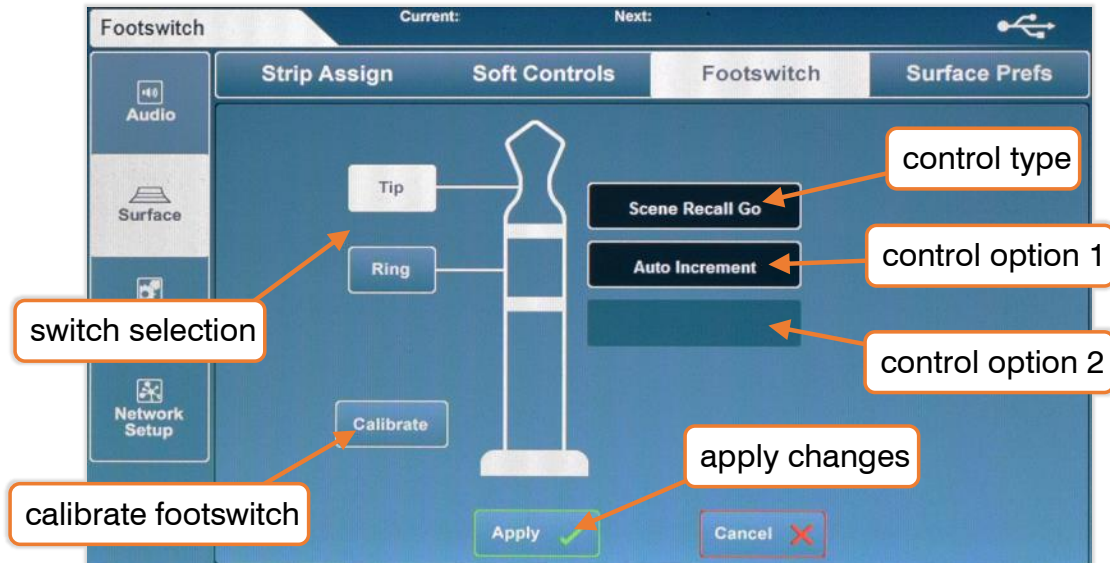

When first connecting a footswitch, touch the '**Calibrate**' button to set the type of switch being used. Follow the on-screen instructions.

- Single footswitches usually use only the '**Tip**' connection.
- You may need to experiment to find which switch is connected to tip or ring with a dual footswitch.

Options for the type of switch are as follows and must match the footswitch hardware:

Unused = Select for a switch you do not wish to use.

Latching = Press and release to switch on, press again to switch off.

Momentary = Press and hold to switch on, release to switch off.

Soft Latch = Enables a momentary switch to be used as a latching switch.

To assign a function to a footswitch:

- 1) Touch either '**Tip**' or '**Ring**' buttons to select a switch.
- 2) Touch the control type value and select a type.
- 3) Touch the control option 1 value (where available) and select an option.
- 4) Touch the control option 2 value (where available) and select an option.
- 5) Touch the '**Apply**' or '**Cancel**' button, to apply or disregard any changes.

ⓘ Possible footswitch assignments are the same as for SoftKeys, with the omission of 'Global Tap Tempo'.

## 12.6 Surface Preferences

Press the '**Setup**' key, then touch the '**Surface**' tab followed by the '**Surface Prefs**' tab to see the surface preferences.



**i** This screen can also be accessed by pressing the '**Brightness**' button on the '**Home**' page.

- Touch the '**Confirm Scene Operations**' button to enable or disable confirmation pop-ups when performing scene overwriting/recalling/deleting operations.
- Touch a parameter dial and adjust using the touchscreen rotary.

Individual controls = Touchscreen brightness, LED brightness, Channel strip brightness, Integrated Surface Illumination brightness, Integrated Surface Illumination colour balance.

The Pre/After Fade Listen settings affect the behaviour of the PAFL bus which is routed to the SQ headphone output and displayed on the 12 segment LED meter as well as being routed to the SQ's [RTA](#).

Press the '**Setup**' screen key, then touch the '**Audio**' tab, followed by the '**PAFL**' tab to display and adjust settings.

- Touch any button on the left of the screen to turn an option on or off.

Additive (On) = Allows multiple channel strips to be routed to the PAFL bus at once.

Sel Follow PAFL (On) = Pressing a PAFL key will also select ('**Sel**') a channel.

PAFL Follow Mix (On) = When PAFL is active on the master/mix channel strip, the channel being routed to PAFL will follow mix selection.

Input Override Mix (On) = When PAFL is in additive mode, pressing the PAFL key of an input channel unassigns mix channels from the PAFL bus.

Unassigning all input channels reassigns the previously assigned mixes.

LR to PAFL (On) = When no other PAFL routing is active, the main LR mix is routed to the PAFL bus.

Output AFL (Off) = Output channels routed to the PAFL bus are pre-fade.  
(Pre-Fade Listen)

Output AFL (On) = Output channels routed to the PAFL bus are post-fade.  
(Post/After Fade Listen)

Input AFL (Off) = Output channels routed to the PAFL bus are pre-fade.  
(Pre-Fade Listen)

Input AFL (On) = Input channels routed to the PAFL bus are post-fade.  
(Post/After Fade Listen)

The PAFL delay can be used to align the PAFL bus when, in a live sound environment, the naturally delayed sound from a sound system can be heard at the same time as the otherwise instant signal fed to headphones or monitors, causing phase issues or an audible delay.

- Touch the millisecond value and adjust using the touchscreen rotary.

PAFL bus delay = 0ms to 682.6ms

The PFL trim attenuates the level of PFL signal routed to the PAFL bus. It does not affect AFL.

- Touch the trim value and adjust using the touchscreen rotary.

PFL Trim = -24dB to 0dB

## 12.8 Audio Sync and AES sample rate



Press the '**Setup**' screen key, then touch the '**Audio**' tab followed by the '**Audio Sync Opts**' tab to see sync and AES digital output sample rate options.

- Touch the '**Audio Clock Source**' value to select a source.

Internal = Sync to the internal audio clock.

SLink = Sync to a digital clock signal being received by the SLink port.

I/O Port = Sync to a digital clock signal being received on the port of a connected option card.

- Touch the '**Apply**' button to apply changes.
-  The SQ will always run at 96kHz internally, even if the clock source it is synchronised to is running at 48kHz.
-  When successfully synchronised, a green tick will be shown to the right of the source selection.
-  When there is no suitable clock being received, a red cross is shown to the right of the source selection and in the SQ title bar.

The sample rate of the digital AES output can be changed if required.

- Touch the current sample rate value, then select an option.

AES Output Sample Rate = 44.1kHz, 48kHz, 88.2kHz, 96kHz

- Touch the '**Apply**' button to apply any changes.

## 12.9 Talkback settings

Talkback is used to enable the engineer to communicate via the audio outputs.

When the **'Talk'** key is pressed, the talkback source is routed to all assigned mixes.

Press the **'Setup'** screen key, then touch the **'Audio'** tab followed by the **'Talkback'** tab to view and adjust the talkback settings.

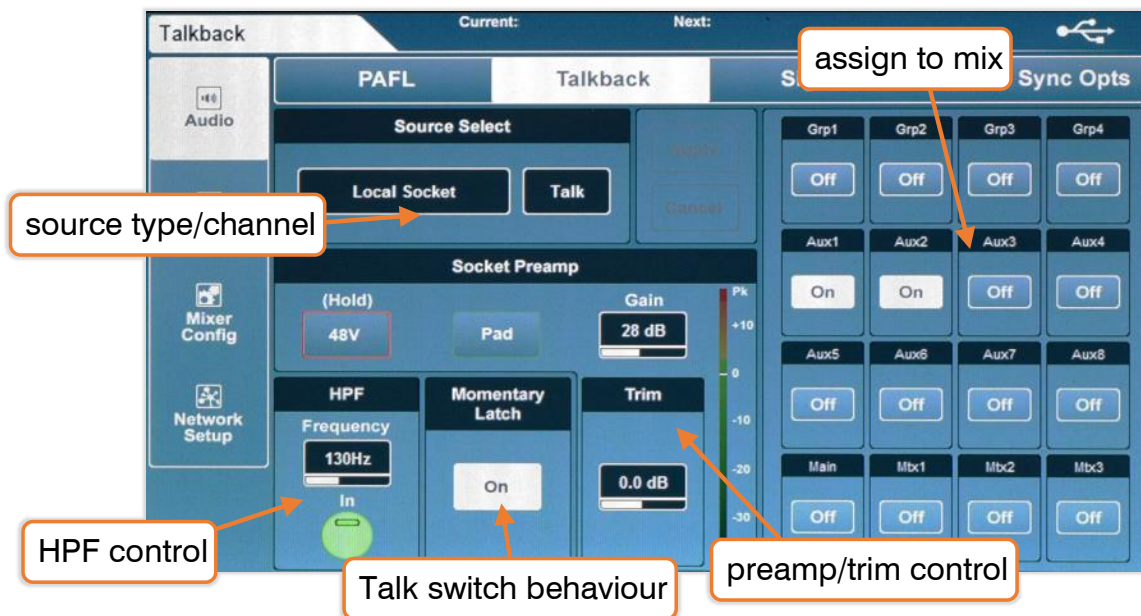

- Source, preamp and trim settings are the same as those used in the Processing/[Preamp](#) screen, and can be adjusted in exactly the same way.
- Similarly, HPF works in the same way as for any input channel in the Processing/[HPF and PEQ](#) screen.
- Touch the momentary latch **'On'** button to enable the **'Talk'** key latching mode. When this mode is on, a quick single press of the **'Talk'** key switches talkback on or off, though the key will continue to work as in momentary mode if held.
- Touch any mix assign button to switch the talkback feed on or off for that mix.

**i** Note that the local **'Talk'** socket can be used as an extra input channel socket. When **'Talk'** is assigned to an input channel, changing preamp settings in the Processing screen for that channel will also change settings in the Talkback setup and vice versa. The same logic applies when a source other than the local **'Talk'** socket is assigned as the Talkback source. The HPF and Trim however, are independent.

## 12.10 Signal Generator

The signal generator can be used to send a signal to a mix for level configuration or used in conjunction with the [RTA](#) and a measurement microphone to check the frequency response of a system.

Press the '**Setup**' screen key, then touch the '**Audio**' tab followed by the '**SigGen**' tab to view and adjust the signal generator settings.

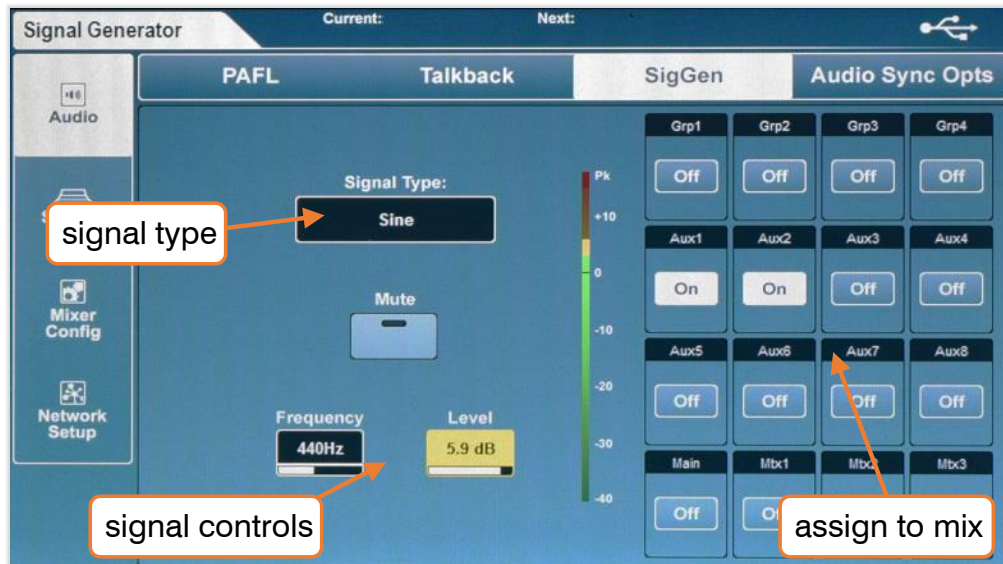

- Touch the '**Signal Type**' value to select a type of signal.

Signal Type = Sine, White noise, Pink noise, Band-pass noise

- Touch the '**Mute**' button to mute or unmute the signal.
- Touch the '**Frequency**' value (where available) and use the touchscreen rotary to adjust.

Frequency = 20Hz to 20kHz

- Touch the '**Level**' value and use the touchscreen rotary to adjust.

Level = -72dB to +18dB

- Touch any mix assign button to assign or unassign the signal generator to or from a mix.

**i** The signal generator can also be used by any input channel. Select '**Signal Generator**' in '**Source Select**' on the Processing/[Preamplifier](#) screen.

For use with any control over Ethernet, such as wireless control or use with MIDI over TCP/IP, the SQ must be connected as a device on a network.

With default settings, the SQ will automatically connect to any network which uses DHCP to assign IP addresses, and will be seen by any apps running on devices connected to the same network.

In some situations, it is necessary or preferable to use a static IP address. It is not recommended to use the static settings unless you fully understand the network you are connecting to.

Press the '**Setup**' screen key, then touch the '**Network Setup**' tab to view and adjust network settings.

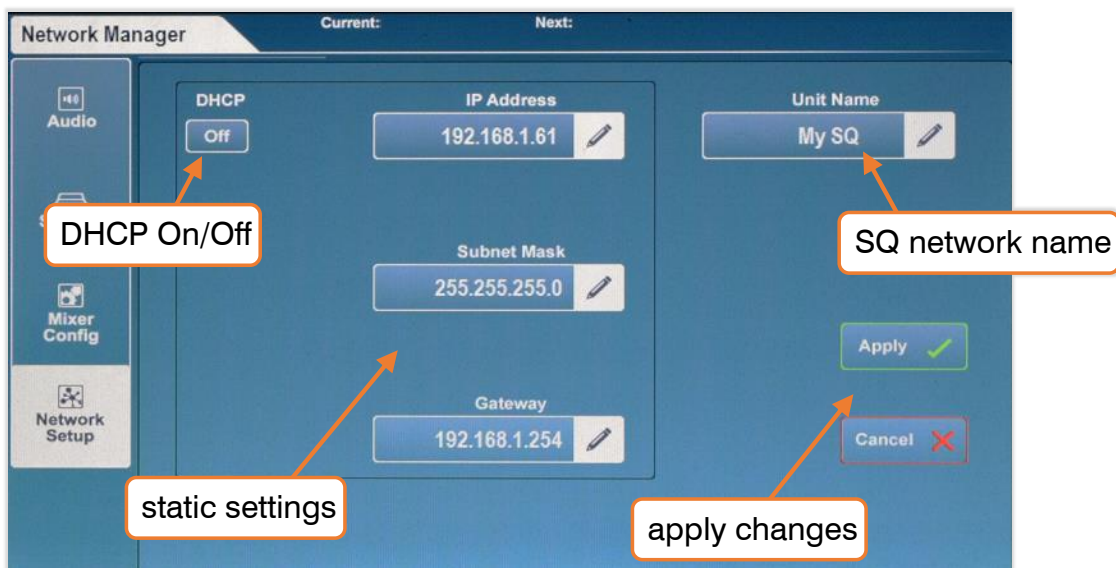

- Touch the DHCP On/Off button to switch DHCP mode on or off. Static settings cannot be adjusted if DHCP mode is on.
- Touch any of the network values to enter new values.
- Touch the '**Unit Name**' value to change the name of the SQ (as seen by other devices on the network).
- Touch the '**Apply**' or '**Cancel**' button to apply or disregard any changes.

**i** When using a wireless router or access point, be sure to connect the SQ's 'Network' port to an available 'LAN' port. The network port 'Lnk' LED on the SQ will illuminate to show network activity.

**i** You can check the current IP address of the SQ by pressing the '**Utility**' screen key, then touching the '**General**' tab followed by the '**Diagnostics**' tab. The IP Address is listed toward the bottom of the information listed.



## 13. SQ-Drive and USB-B

SQ-Drive and USB-B make use of the same audio technology inside SQ, so they run exclusively from one another. Therefore, you must choose which mode the SQ is running in before recording or playing back any audio.

There are other bandwidth intensive tasks (such as formatting an SQ-Drive) that also require the mode to be changed.

Press the 'I/O' screen key, then touch the USB tab to display USB input or output patching.



The 'USB Source' switch displayed at the top left of the matrix shows the current mode.

- Touch the 'USB Source' switch to change between 'SQ-Drive' and 'USB-B' mode.
- Audio patching for both the SQ-Drive and USB-B connection is the same.
- SQ-Drive utilises only the patching from channels 1 to 16 on both inputs and outputs. USB-B streaming can utilise all USB input and output channels (32 x 32).

## 13.1 SQ-Drive stereo recording and playback

Press the '**Utility**' screen key then touch the '**SQ-Drive**' tab followed by the '**Stereo**' tab to show the SQ-Drive Stereo record/playback screen.

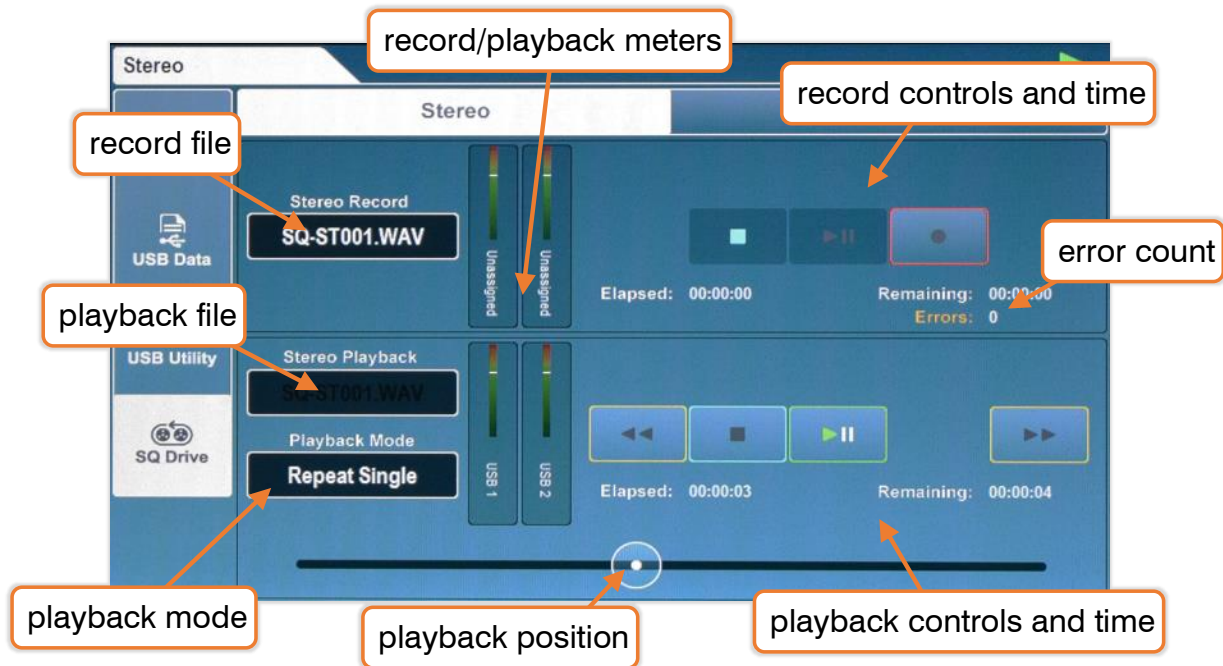

The top half of the screen is for recording and the bottom half is for playback.

### Recording -

- Press the record button to arm recording, a new '**Stereo Record**' file name will appear, the '**Remaining**' time value will be displayed and the '**Errors**' counter will reset.
- Press the play/pause button to start recording, the '**Elapsed**' and '**Remaining**' time values will display progress.
- Press the stop button to stop recording.

**i** The '**Errors**' counter increments with any detected writing error. It is a good measure of USB device suitability for recording.

## Playback –

- Touch the '**Stereo Playback**' file name value. Then touch the '**Playback**' or '**Recording**' button to view files in each folder (recordings you have made with the SQ are displayed in the '**Recordings**' folder).
- Touch a track to select it, then scroll through the list of tracks using the touchscreen rotary if needed.
- Touch the '**Select**' button to load the track.
- Touch the '**Playback Mode**' value to select a mode.

Play All = Play all tracks in the folder consecutively.

Play Single = Play the selected track then stop.

Repeat All = Repeatedly play all tracks in the folder consecutively.

Repeat Single = Repeatedly play the selected track.

- Touch the transport buttons to go to the previous or next track, or to stop or play/pause.
- Touch and drag the circular playback position marker to jump to a different point in the track.

## Formats and folders –

SQ-Drive stores stereo recordings to '`<SQ-DRIVE>:\AHSQ\USBREC`'.

These are 96kHz 24bit stereo \*.wav files, named sequentially in the order recorded i.e. SQ-ST001.WAV, SQ-ST002.WAV...

Files for stereo playback copied from a computer should be placed in '`<SQ-DRIVE>:\AHSQ\USBPLAY`'.

These can be mono or stereo, uncompressed PCM \*.wav files, 44.1, 48 or 96kHz and 16 or 24-bit.

They must not contain any headers (such as BWF) or data (such as markers).

## 13.2 SQ-Drive multitrack recording and playback

Press the '**Utility**' screen key then touch the '**SQ-Drive**' tab followed by the '**Multitrack**' tab to show the SQ-Drive Multitrack record/playback screen.

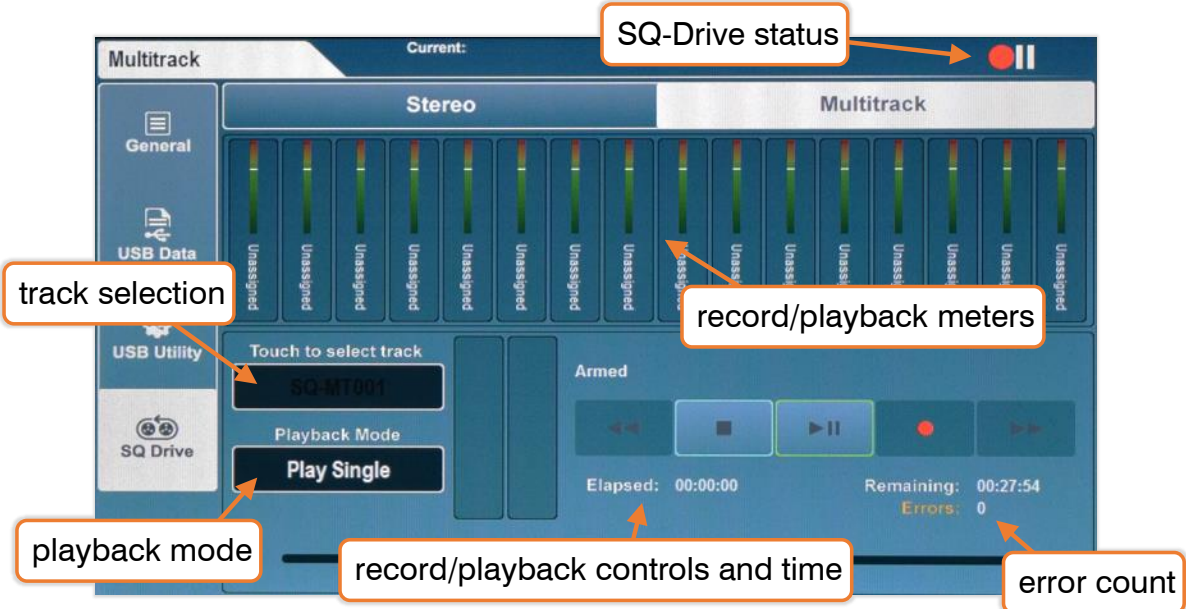

### Recording -

- Press the record button to arm recording, a new multitrack file name will appear, the '**Remaining**' time value will be displayed and the '**Errors**' counter will reset.
- Press the play/pause button to start recording, the '**Elapsed**' and '**Remaining**' time values will display progress.
- Press the stop button to stop recording.

### Playback –

- Touch the multitrack file name value. Touch a track to select it, then scroll through the list of tracks using the touchscreen rotary if needed.
- Touch the '**Select**' button to load the track.
- Touch the '**Playback Mode**' value to select a mode.

Play All = Play all tracks in the folder consecutively.

Play Single = Play the selected track then stop.

Repeat All = Repeatedly play all tracks in the folder consecutively.

Repeat Single = Repeatedly play the selected track.

- Touch the transport buttons to go to the previous or next track, or to stop or play/pause.
- Touch and drag the circular playback position marker to jump to a different point in the track.

- ❗ The '**Errors**' counter increments with any detected writing error. So it is a good measure of USB device suitability for recording.
- ❗ Not all USB devices are capable of the high bandwidth used by the SQ-Drive multitrack recording feature. For best results when multitrack recording direct to USB, use a high-speed external hard drive rather than a USB stick/'pen' drive.

### Formats and folders –

SQ-Drive stores multitrack recordings to separate folders in the parent folder '<SQ-DRIVE>:\AHSQ\USBMTK'. Folders are named sequentially in the order recordings are made. i.e. 'SQ-MT001', 'SQ-MT002'...

Sixteen 96kHz 24bit mono uncompressed PCM \*.wav files are recorded – with naming based on the USB channel i.e. 'TRK01.WAV', 'TRK02.WAV'...

They do not contain any headers (such as BWF) or data (such as markers).

Files for multitrack playback copied from a computer should follow this exact formatting, naming and folder structure. Files must also be exactly the same size/length and all sixteen files must be present, even if they contain no audio.

## 13.3 Connecting to a computer

To stream audio to and from a computer, it needs to be connected to the SQ using a USB-A to USB-B cable.

SQ conforms to USB 2.0 standards, so it is recommended to use a high-speed USB cable. Depending on the environment the system is being used in, it may also be beneficial to use a cable which features a ferrite bead.

- ⓘ Note that not all USB 3.0 ports are fully backward compatible with USB 2.0 – for best results, it is therefore recommended that a USB 2.0 port is used where available. Where unavailable, USB 3.0 ports utilising xHCI host controller drivers should be avoided as many are known not to support the isochronous transfer method used for streaming audio.

### To connect SQ to a mac –

The SQ is Core Audio compliant so drivers are not required.

Connect the SQ via USB and it will appear as both an audio and a MIDI device.

### To connect SQ to a Windows PC –

Visit the Allen & Heath website ([www.allen-heath.com](http://www.allen-heath.com)) to download the latest SQ Windows ASIO/WDM drivers.

Follow the instructions to install the drivers before connecting the SQ.

### Routing –

- It is important to note when patching, that outputs from the computer are inputs on the SQ and outputs on the SQ are inputs on the computer.
- All USB I/O must be patched to function, though by default, SQ input channels 47 and 48 are sourced from USB channels 1 and 2, and USB output channels 1 and 2 are fed from the Main LR mix.
- When using WDM drivers to utilise the SQ for Windows system/default sound, only USB channels 1 and 2 are used on the SQ. To make use of all 32 input and 32 output channels, the ASIO driver must be used with a compatible program.

When selecting the SQ as the default output audio device on a mac, USB channels 1 and 2 are used by default.

## 14. MIDI and DAW Control

When connected to a computer either via USB or TCP/IP, the SQ sends and receives MIDI control messages.

These can be broken down into two sets of bi-directional messages. Those that are used to control the SQ, and those used to control external software or equipment.

The MIDI protocol for control and automation of the SQ is outside of the scope of this guide. Visit [www.allen-heath.com](http://www.allen-heath.com) to download the latest available MIDI protocol documentation.

### 14.1 MIDI channel and MMC

Press the '**Utility**' screen key, then touch the '**General**' tab followed by the '**MIDI**' tab to view and adjust the MIDI channel setting. This screen also displays MMC (MIDI Machine Control) buttons for control of computer sequencers and DAW's.

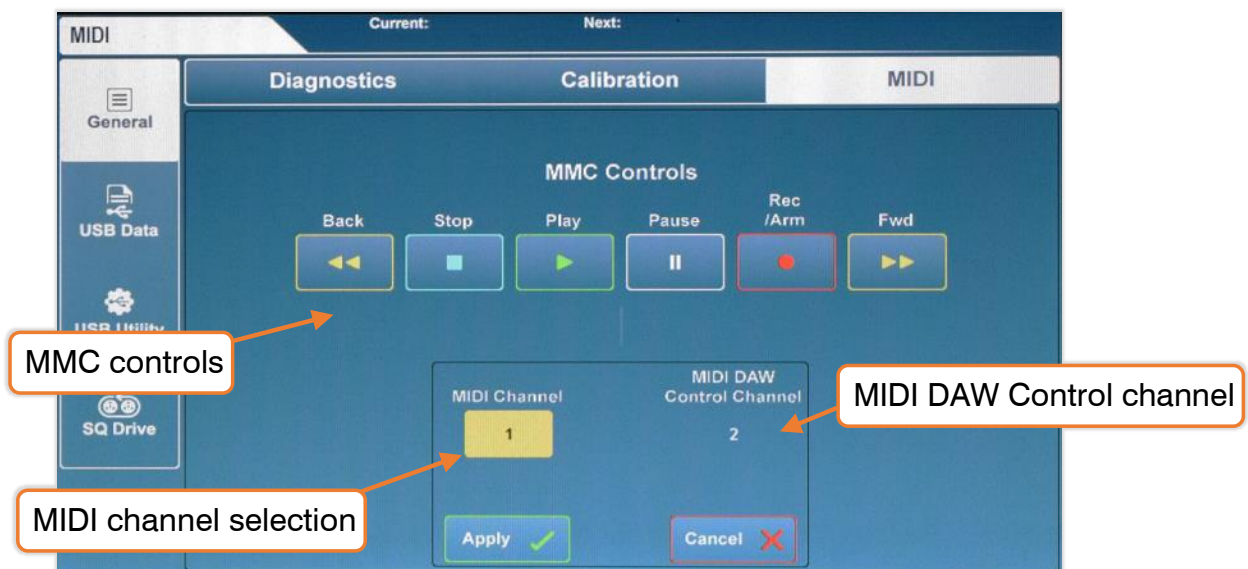

- Touch the '**MIDI Channel**' value and use the touchscreen rotary to adjust.
- Touch the '**Apply**' or '**Cancel**' buttons to apply or disregard changes.
- ⓘ Note that the channel used by the Allen & Heath DAW Control Driver (and therefore all MIDI fader strips) is always one more than the MIDI Channel the rest of the SQ is set to. To use MIDI channel 1 for the DAW Control Channel, set the main SQ MIDI channel to 16.
- Touching any of the MMC Controls sends standard MMC transport messages to all channels. These are also translated by the DAW control driver to specific transport messages for the control surface emulation being used.

## 14.2 MIDI fader strips

The SQ has 32 available MIDI fader strips that can be assigned anywhere in the fader strip layers.

These transmit standard MIDI messages over USB and TCP/IP when 'Mute', 'Sel' or 'PAFL' keys are pressed, or when the fader strip fader is adjusted. They also respond to the same messages.

- Messages can be used as-is, and 'learnt' by software for control.
- By default, these messages are transmitted on MIDI Channel 2.
- Pressing a key will send a note on followed by a note off, moving a fader sends a continuous change message.

SQ MIDI Fader Strip Control	MIDI message
Mute keys 1 to 32	Note On/Off 0 (C-1) to 31 (G1)
Sel keys 1 to 32	Note On/Off 32 (G#1) to 63 (Eb4)
PAFL keys 1 to 32	Note On/Off 64 (E4) to 95 (B6)
Faders 1 to 32	CC 00 to CC 31

## 14.3 DAW Control

MIDI fader strips can also be used with the Allen & Heath DAW Control Driver. This translates the messages from the MIDI strip and emulates standard control surface messages for use with a DAW.

Visit [www.allen-heath.com](http://www.allen-heath.com) to download the latest DAW Control Driver and view instructions for installation and correct setup.

It is worth noting that [SoftKeys](#) can also be assigned to send MMC messages or 'Bank Up', 'Bank Down' messages.

- ⓘ Only the MIDI fader strips, MMC controls and specific SoftKey assignments are intended for use with the DAW Control Driver. Other physical controls (such as EQ rotaries) continue to work with the SQ itself.



# 15. Mix/System Reset

## 15.1 Reset Mix Settings

To return the SQ to a known state (to 'zero the desk'), press the '**Scenes**' screen key, then touch the '**Scene Manager**' tab. Touch and hold the '**Reset Mix Settings**' button and a confirmation pop-up will be displayed.

**i** Global filters are ignored and safes are all switched off when mix settings are reset.

Some key default settings are as follows.

Routing	Setting
Mix Bus Configuration	Aux 1-4 (mono), Aux 5-8 (stereo), Group 9-12 (Stereo)
Local Input patching	1 to 1 (as labelled), then unassigned to 46
Local Output patching (Aux)	1 to 1 for mono, then ordered for stereo
Local Output patching (Main)	11 (Main L) & 12 (Main R)
Local Output patching (Matrix 1)	A & B
AES output	Main LR
Remote Audio Unit Inputs	Unassigned
Remote Audio Unit Outputs	Mixes 1 to 1, then Main LR on last 2 sockets.
SQ to USB	Main LR on 1 & 2, then 1 to 1 direct out
USB to SQ	USB 1 & 2 to input channels 47 & 48

Processing type	Setting
48v	All off
Preamp gains	+ 28dB
HPFs	Out/100Hz
Gates	Out/-30dB
Inserts	Out
PEQs	In/Flat
GEQs	In/Flat
Compressors	Out/3:1/-9dB
Pans	Centred

Control	Setting
SoftKeys 1-6	Mute Groups 1 to 6
SoftKey 7	Unassigned
SoftKey 8	Global Tap Tempo
SoftKeys 9-16	Unassigned
SoftRotaries	Unassigned

FX unit	Setting
1	EMT 250 reverb/FX1Snd/FX1Rtn
2	Hall 480 reverb/FX2Snd/FX2Rtn
3	Stereo Tap Vocal Delay/FX3Snd/FX3Rtn
4	ADT Classic/FX4Snd/FX4Rtn
5-8	Empty/Unpatched

Send type	Level
Input channels	-inf
FX return channels	0dB
Main LR master	0dB
Aux master	0dB
Group master	-inf
FX master	0dB

## 15.2 System reset

To perform a full system reset, hold the EQ **'In'** and **'HF'** keys when powering on the SQ. This will clear all mix settings and all saved data, including Shows/Scenes and Libraries, so back-up any data you wish to keep using [SQ-Drive](#).

## 15.3 Fader Calibration

Occasionally faders can become misaligned, this can happen for many reasons and is usually nothing to be concerned about. However, it may necessitate a re-calibration.

- 1) Press the **'Utility'** screen key, then touch the **'General'** tab followed by the **'Calibration'** tab.
- 2) Touch the **'Calibrate'** button and follow the on-screen instructions, positioning the faders at +10dB, 0dB, -10dB, -30dB and -inf when prompted.
- 3) Restart the SQ.

# 16. Block Diagrams

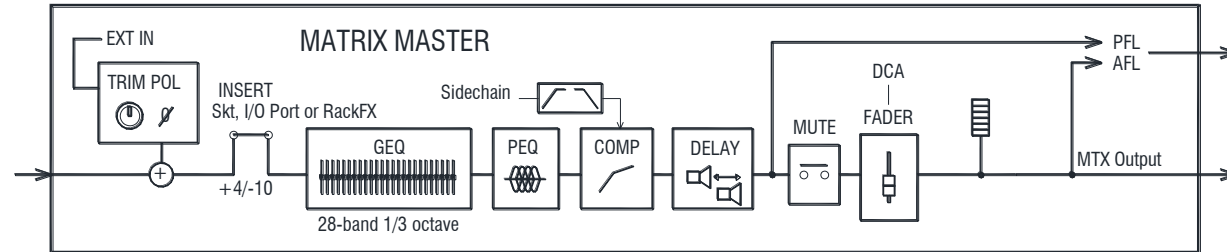
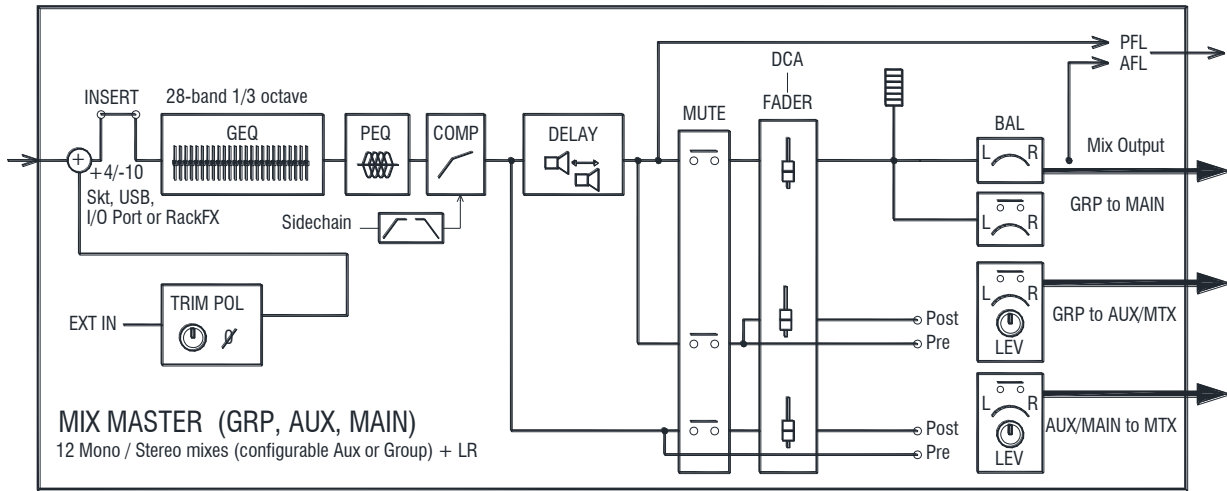
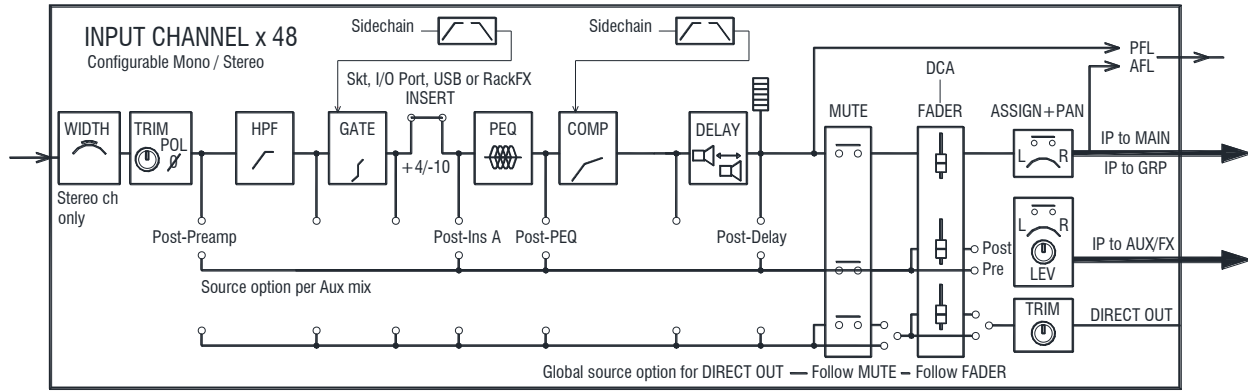

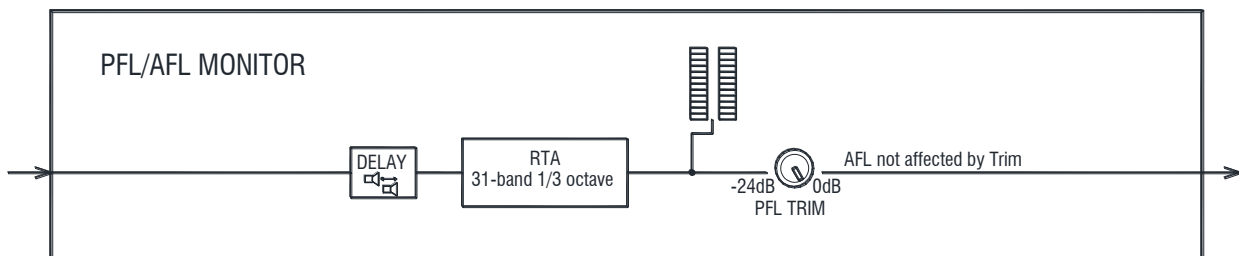
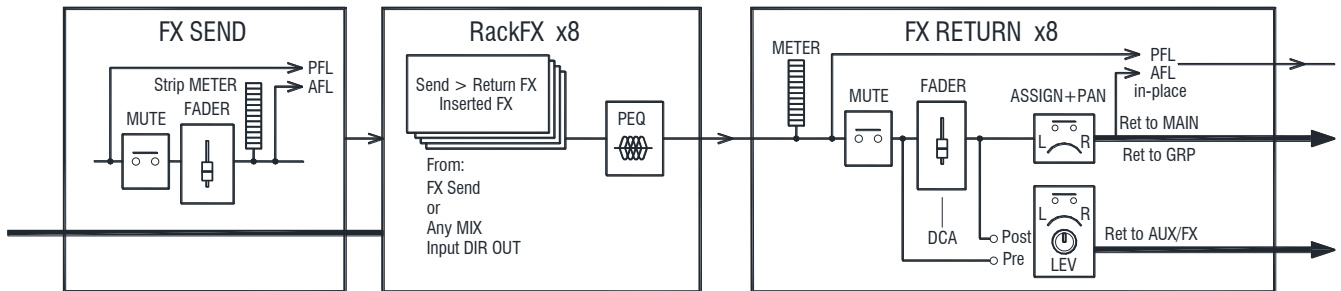
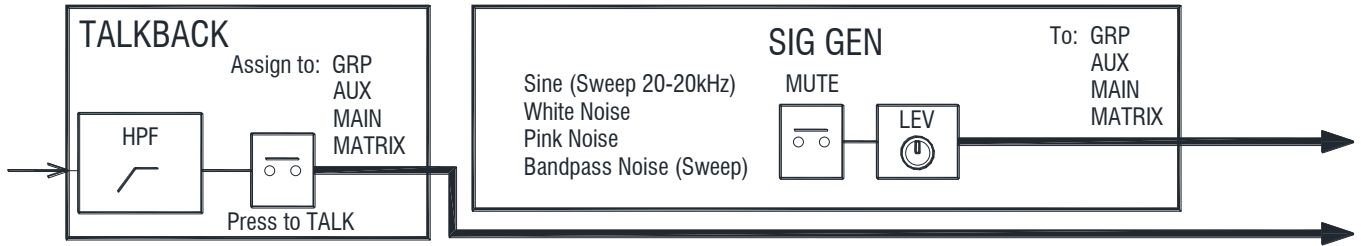

## 17. Specifications

### Mic/Line Inputs

Balanced XLR, fully recallable	
Input Sensitivity	-60 to +0dBu
Switchable Pad	-20dB
Analogue Gain	0dB to +60dB, 1dB steps
Maximum Input Level	+30dBu
Input Impedance	>5k $\Omega$
THD+N, Unity gain 0dB	0.002% -92dBu (20Hz-20kHz, AES Direct Out, @0dBu 1kHz)
THD+N, Mid gain +30dB	0.003% -91dBu (20Hz-20kHz, AES Direct Out, @-30dBu INPUT 1kHz)
Phantom Power	+48V (+3V / -2V)

### Stereo Line Inputs

Balanced, 1/4" TRS jack	
ST1, ST2 connectors	Balanced, 1/4" TRS jack
ST3 connector	Unbalanced, stereo 3.5mm Mini Jack
Input Sensitivity (ST1, ST2 / ST3)	Nominal +4dBu ST1, ST2 / 0dBu ST3
Trim	+/-24dB
Maximum Input Level (ST1, ST2 / ST3)	+22dBu / +18dBu
Input Impedance	>7k $\Omega$

### Outputs 1-12 (SQ-5) and 1-14 (SQ-6)

Balanced, XLR	
Outputs A and B	Balanced 1/4" TRS Jack
Source	Patchable
Output Impedance	<75 $\Omega$
Nominal Output	+4dBu = 0dB meter reading
Maximum Output Level	+22dBu
Residual Output Noise	-90dBu (muted, 20Hz-20kHz)

### AES Digital Output

Balanced XLR 2 channel,
96kHz sampling rate (Default with SRC Bypassed)
Switchable output sample rates, 44.1kHz/ 48kHz/ 88.2kHz/ (96kHz)
2.5Vpp balanced terminated 110 $\Omega$

<b>SLink Connection</b>	Neutrik EtherCON (RJ45)
<b>dSnake mode (48kHz devices)</b>	64 channels assignable, compatible with AR2412, AR84, AB168, ME
<b>dx mode (96kHz devices)</b>	32 channels assignable, compatible with DX168
<b>gigaACE (96kHz devices)</b>	128 channels assignable, compatible with dLive and SQ
<b>Inputs</b>	Fully Patchable
<b>Outputs</b>	Fully Patchable
<b>Sync/SRC</b>	assignable as master audio sync for all modes, SRC 64 channel
<b>I/O Port</b>	Multi-channel IO option module
<b>Inputs</b>	Fully Patchable
<b>Outputs</b>	Fully Patchable
<b>Sync/SRC</b>	assignable as master audio sync
<b>System</b>	Measured balanced XLR in to XLR out, 0dB gain, 0dBu input
Dynamic Range	112 dB
Frequency Response	+0/-0.5dB 20Hz to 20kHz
Headroom	+18dB
Internal operating Level	0dBu
THD+N, Mic/Line routed to Main L/R Out	Unity gain faders@0dB, 0.006%, -84dBu (20 - 20kHz)
dBFS Alignment	+18dBu = 0dBFS (+22dBu at XLR output)
Meter Calibration	0dB meter = -18dBFS (+4dBu at XLR out)
Main Meter Type	2 x 12 segment, fast (peak) response
Channel Meter Type	Chromatic Channel Metering, fully programmable colour/brightness
Peak Indication	-3dBFS (+19dBu at XLR out), multi-point sensing
Sampling Rate	96kHz
Bit Depth	Uses XCVI core custom bit widths in algorithms, up to 96bits
Latency	<0.7mS, Local Mic Input routed to Main L/R. (Direct, No EQ/ Effects)
Operating Temperature Range	0 deg C to 40 deg C (32 deg F to 104 deg F)
Mains Power	100-240V AC, 50/60Hz
Max Power Consumption SQ-5/SQ-6	75W / 90W

## Input Processing

### Source

CH1-48	Fully patchable
USB Global Source	SQ-Drive or USB-B Streaming

### Polarity

Normal/Invert

### Trim

-24 to +24dB

### High Pass Filter

12dB/octave 20Hz – 2kHz

### Insert (Pre EQ/Comp)

Fully Patchable

### Delay

Up to 341ms

### Gate

Patchable Sidechain

Sidechain filter

Hi-pass (20-5k), Band-pass (120-10k), Lo-pass (120-20k)

Threshold / Depth

-72dBu to +18dBu / 0 to 60dB

Attack / Hold / Release

50µs to 300ms / 10ms to 5s / 10ms to 1s

### PEQ

4-Band fully parametric, 20-20kHz, +/-15dB

Band 1, Band 4

Selectable Shelving (Baxandall), Bell

Band 2, Band 3

Bell

Bell Width

Variable Q, 1.5 to 1/9th octave

### Compressor

Patchable Sidechain

Sidechain filter

Hi-pass (20-5k), band-pass (120-10k), Lo-pass (120-20k), Q=1

Threshold / Ratio

-46dBu to 18dBu / 1:1 to infinity

Attack / Release

30µs to 300ms / 50ms to 2s

Knee

Soft/Hard

Detector response

Peak/RMS switchable

Parallel Path Compression

dry/wet -inf to 0dB

### Channel Direct Out

Follow Fader, Mute, Mute Group, DCA (global all ch)

Source select

Post-Preamp, Post-HPF, Post-Gate, Insert Return,

Post-PEQ, Post-Comp, Post-Delay

trim -inf to 10dB per channel

## Mix Processing

<b>Insert</b> (Pre EQ/Comp)	Fully Patchable
<b>Delay</b>	Up to 682ms
<b>GEQ</b>	28 bands 31Hz-16kHz, +/-12dB Gain, Constant 1/3 oct
<b>PEQ</b>	As Input PEQ
<b>Compressor</b>	As Input Compressor

## FX

Internal FX	8 x RackExtra FX engine, Send>Return or Inserted (4 dedicated FX bus)
Types	SMR Reverb, Gated Reverb, Stereo Tap Delay, ADT, Symphonic Chorus, Flanger
8 dedicated Stereo FX returns	Fader, Pan, Mute, Routing to Mix/LR, 4-Band PEQ

## Audio Tools

<b>PAFL</b>	PFL or stereo in-place AFL, 0 to -24dB Trim, PAFL Delay Up to 682ms
<b>Talkback</b>	Dedicated input, Assignable to any mix, Gain, Pad, 48V, 12dB/oct HPF
<b>Signal Generator</b>	Assignable to any mix, Sine/White/Pink/Bandpass Noise
<b>RTA</b>	31-Bands 1/3 octave 20-20kHz, follows PAFL source

## USB Audio

<b>SQ-Drive</b>	USB A
Stereo Record	2 channel, WAV, 96kHz, 24-bit, source fully patchable
Stereo Playback	1/2 channel, WAV, 44.1, 48, 96kHz 16, 24-bit, fully patchable
Multitrack Record	16 channel, WAV, 96kHz, 24-bit, track sources fully patchable
Multitrack Playback	16 channel, WAV, 96kHz, 24-bit fully patchable
<b>USB Audio Streaming</b>	USB B, Core Audio compliant, ASIO/WDM for Windows
Send (upstream)	32 channel, 96kHz, 24-bit
Return (downstream)	32 channel, 96kHz, 24-bit



## Size and Weight

### SQ-5

Width x Depth x Height

Desk mounted	440 x 514.9 x 198 mm (17.3" x 20.3" x 7.8")
Packed in shipping box	610 x 680 x 360 mm (24" x 26.8" x 14.2")
Unpacked weight	10.5 kg (23.1 lbs)
Packed weight	14 kg (30.9 lbs)

### SQ-6

Width x Depth x Height

Desk mounted	638 x 514.9 x 198 mm (25.1" x 20.3" x 7.8")
Packed in shipping box	820 x 680 x 360 mm (32.3" x 26.8" x 14.2")
Unpacked weight	13.3 kg (29.3 lbs)
Packed weight	17.3 kg (38.1 lbs)

## 18. Warranty Information

### Limited One Year Manufacturer's Warranty

Allen & Heath warrants the Allen & Heath -branded hardware product and accessories contained in the original packaging ("Allen & Heath Product") against defects in materials and workmanship when used in accordance with Allen & Heath's user manuals, technical specifications and other Allen & Heath product published guidelines for a period of ONE (1) YEAR from the date of original purchase by the end-user purchaser ("Warranty Period").

This warranty does not apply to any non-Allen & Heath branded hardware products or any software, even if packaged or sold with Allen & Heath hardware.

Please refer to the licensing agreement accompanying the software for details of your rights with respect to the use of software/firmware ("EULA").

Details of the EULA, warranty policy and other useful information can be found on the Allen & Heath website: [www.allen-heath.com/legal](http://www.allen-heath.com/legal).

Repair or replacement under the terms of the warranty does not provide right to extension or renewal of the warranty period. Repair or direct replacement of the product under the terms of this warranty may be fulfilled with functionally equivalent service exchange units.

This warranty is not transferable. This warranty will be the purchaser's sole and exclusive remedy and neither Allen & Heath nor its approved service centres shall be liable for any incidental or consequential damages or breach of any express or implied warranty of this product.

### Conditions of Warranty

The equipment has not been subject to misuse either intended or accidental, neglect, or alteration other than as described in the User Guide or Service Manual, or approved by Allen & Heath. The warranty does not cover fader wear and tear.

Any necessary adjustment, alteration or repair has been carried out by an authorised Allen & Heath distributor or agent. The defective unit is to be returned carriage prepaid to the place of purchase, an authorised Allen & Heath distributor or agent with proof of purchase. Please discuss this with the distributor or the agent before shipping. Units returned should be packed in the original carton to avoid transit damage.

**DISCLAIMER:** Allen & Heath shall not be liable for the loss of any saved/stored data in products that are either repaired or replaced.

Check with your Allen & Heath distributor or agent for any additional warranty information which may apply. If further assistance is required please contact Allen & Heath Ltd.

Any changes or modifications to the equipment not approved by Allen & Heath could void the compliance of the product and therefore the user's authority to operate it.

SQ Reference Guide, Firmware V1.0.1, issue 1.

Copyright © 2017 Allen & Heath. All rights reserved.

# ALLEN & HEATH

Allen & Heath Limited, Kernick Industrial Estate, Penryn, Cornwall, TR10 9LU, UK

[www.allen-heath.com](http://www.allen-heath.com)